



# Intel® Desktop Board D815EEA2/D815EPEA2 Technical Product Specification



*May 2001*

*Order Number A46399-002*

The Intel® Desktop Boards D815EEA2 and D815EPEA2 may contain design defects or errors known as errata that may cause the product to deviate from published specifications. Current characterized errata are documented in the Intel Desktop Board D815EEA2/D815EPEA2 Specification Update.

# Revision History

---

Revision	Revision History	Date
-001	First release of the Intel® Desktop Board D815EEA2/D815EPEA2 Technical Product Specification	February 2001
-002	Second release of the Intel® Desktop Board D815EEA2/D815EPEA2 Technical Product Specification	May 2001

This product specification applies to only standard D815EEA2 and D815EPEA2 boards with BIOS identifier EA81520A.86A.

Changes to this specification will be published in the Intel Desktop Board D815EEA2/D815EPEA2 Specification Update before being incorporated into a revision of this document.

Information in this document is provided in connection with Intel® products. No license, express or implied, by estoppel or otherwise, to any intellectual property rights is granted by this document. Except as provided in Intel's Terms and Conditions of Sale for such products, Intel assumes no liability whatsoever, and Intel disclaims any express or implied warranty, relating to sale and/or use of Intel products including liability or warranties relating to fitness for a particular purpose, merchantability, or infringement of any patent, copyright or other intellectual property right. Intel products are not intended for use in medical, life saving, or life sustaining applications.

Intel may make changes to specifications and product descriptions at any time, without notice.

The Intel® Desktop Board D815EEA2 and the Intel® Desktop Board D815EPEA2 may contain design defects or errors known as errata that may cause the product to deviate from published specifications. Current characterized errata are available on request.

Contact your local Intel sales office or your distributor to obtain the latest specifications before placing your product order.

Copies of documents which have an ordering number and are referenced in this document, or other Intel literature, may be obtained from:

Intel Corporation  
P.O. Box 5937  
Denver, CO 80217-9808

or call in North America 1-800-548-4725, Europe 44-0-1793-431-155, France 44-0-1793-421-777,  
Germany 44-0-1793-421-333, other Countries 708-296-9333.

Intel, Pentium, Celeron, and LANDesk are trademarks or registered trademarks of Intel Corporation or its subsidiaries in the United States and other countries.

† Other names and brands may be claimed as the property of others.

Copyright © 2001, Intel Corporation. All rights reserved.

# Preface

---

This Technical Product Specification (TPS) specifies the board layout, components, connectors, power and environmental requirements, and the BIOS for these Intel Desktop Boards: D815EEA2 and D815EPEA2. It describes the standard product and available manufacturing options.

## Intended Audience

The TPS is intended to provide detailed, technical information about the D815EEA2 and D815EPEA2 boards and their components to the vendors, system integrators, and other engineers and technicians who need this level of information. It is specifically *not* intended for general audiences.

## What This Document Contains

Chapter	Description
1	A description of the hardware used on the D815EEA2 and D815EPEA2 boards
2	A map of the resources of the board
3	The features supported by the BIOS Setup program
4	The contents of the BIOS Setup program's menus and submenus
5	A description of the BIOS error messages, beep codes, and POST codes

## Typographical Conventions

This section contains information about the conventions used in this specification. Not all of these symbols and abbreviations appear in all specifications of this type.

## Notes, Cautions, and Warnings

### ⇒ NOTE

*Notes call attention to important information.*



### CAUTION

*Cautions are included to help you avoid damaging hardware or losing data.*



### WARNING

*Warnings indicate conditions, which if not observed, can cause personal injury.*

## Other Common Notation

#	Used after a signal name to identify an active-low signal (such as USBP0#)
(NxnX)	When used in the description of a component, N indicates component type, xn are the relative coordinates of its location on the D815EEA2 and D815EPEA2 boards, and X is the instance of the particular part at that general location. For example, J5J1 is a connector, located at 5J. It is the first connector in the 5J area.
GB	Gigabyte (1,073,741,824 bytes)
KB	Kilobyte (1024 bytes)
Kbit	Kilobit (1024 bits)
kbits/sec	1000 bits per second
MB	Megabyte (1,048,576 bytes)
MB/sec	Megabytes per second
Mbit	Megabit (1,048,576 bits)
Mbit/sec	Megabits per second
xxh	An address or data value ending with a lowercase h indicates a hexadecimal value.
x.x V	Volts. Voltages are DC unless otherwise specified.
†	This symbol is used to indicate third-party brands and names that are the property of their respective owners.

# Contents

---

## 1 Product Description

1.1	Board Differences.....	12
1.1.1	Feature Level Differences .....	12
1.1.2	Identifying Universal Boards.....	13
1.2	Overview .....	14
1.2.1	Feature Summary.....	14
1.2.2	Manufacturing Options .....	15
1.2.3	Board Layout.....	16
1.2.4	Block Diagrams .....	17
1.3	Online Support.....	19
1.4	Operating System Support.....	19
1.5	Design Specifications .....	20
1.6	Processor .....	23
1.7	System Memory.....	24
1.8	Chipsets .....	26
1.8.1	Intel® 815E Chipset.....	26
1.8.2	Intel® 815EP Chipset .....	31
1.9	I/O Controller .....	36
1.9.1	Serial Ports.....	36
1.9.2	Parallel Port.....	37
1.9.3	Diskette Drive Controller.....	37
1.9.4	Keyboard and Mouse Interface.....	37
1.10	Graphics Subsystems.....	38
1.10.1	Intel 815E Graphics Subsystem .....	38
1.10.2	Intel 815EP Graphics Subsystem .....	42
1.11	Audio Subsystem.....	43
1.11.1	AD1885 Audio Codec.....	43
1.11.2	Audio Connectors.....	43
1.12	LAN Subsystem (Optional) .....	45
1.12.1	Intel® 82562ET Platform LAN Connect Device .....	45
1.12.2	RJ-45 LAN Connector LEDs.....	45
1.13	Hardware Management Subsystem.....	46
1.13.1	Hardware Monitor Component.....	46
1.13.2	Chassis Intrusion Detect Connector (Optional).....	46
1.13.3	Fan Control and Monitoring .....	47
1.14	CNR Connector (Optional).....	47
1.15	Power Management.....	48
1.15.1	Software Support.....	48
1.15.2	Hardware Support .....	52

## 2 Technical Reference

2.1	Introduction.....	57
2.2	Memory Map .....	57
2.3	I/O Map.....	58

2.4	DMA Channels .....	60
2.5	PCI Configuration Space Map .....	60
2.6	Interrupts .....	61
2.7	PCI Interrupt Routing Map .....	61
2.8	Connectors .....	63
2.8.1	Back Panel Connectors .....	64
2.8.2	Internal I/O Connectors .....	68
2.8.3	External I/O Connectors .....	78
2.9	Jumper Blocks .....	82
2.9.1	Front Panel Audio Connector/Jumper Block .....	82
2.9.2	BIOS Setup Configuration Jumper Block .....	83
2.10	Mechanical Considerations .....	84
2.10.1	Form Factor .....	84
2.10.2	I/O Shields .....	85
2.11	Electrical Considerations .....	92
2.11.1	Power Consumption .....	92
2.11.2	Add-in Board Considerations .....	94
2.11.3	Standby Current Requirements .....	94
2.11.4	Fan Connector Current Capability .....	95
2.11.5	Power Supply Considerations .....	95
2.12	Thermal Considerations .....	96
2.13	Reliability .....	97
2.14	Environmental .....	98
2.15	Regulatory Compliance .....	99
2.15.1	Safety Regulations .....	99
2.15.2	EMC Regulations .....	99
2.15.3	Product Certification Markings (Board Level) .....	100

### 3 Overview of BIOS Features

3.1	Introduction .....	101
3.2	BIOS Flash Memory Organization .....	102
3.3	Resource Configuration .....	102
3.3.1	PCI Autoconfiguration .....	102
3.3.2	IDE Support .....	102
3.4	System Management BIOS (SMBIOS) .....	103
3.5	Legacy USB Support .....	104
3.6	BIOS Updates .....	105
3.6.1	Language Support .....	105
3.6.2	Custom Splash Screen .....	105
3.7	Recovering BIOS Data .....	106
3.8	Boot Options .....	107
3.8.1	CD-ROM and Network Boot .....	107
3.8.2	Bootting without Attached Devices .....	107
3.9	Fast Booting Systems with Intel® Rapid BIOS Boot .....	107
3.9.1	Peripheral Selection and Configuration .....	108
3.9.2	Intel Rapid BIOS Boot .....	108
3.9.3	Operating System Selection .....	108
3.10	BIOS Security Features .....	109

## 4 BIOS Setup Program

4.1	Introduction.....	111
4.2	Maintenance Menu .....	112
4.2.1	Extended Configuration Submenu.....	113
4.3	Main Menu.....	114
4.4	Advanced Menu.....	115
4.4.1	PCI Configuration Submenu.....	116
4.4.2	Boot Configuration Submenu .....	117
4.4.3	Peripheral Configuration Submenu.....	118
4.4.4	IDE Configuration Submenu.....	120
4.4.5	Diskette Configuration Submenu.....	123
4.4.6	Event Log Configuration Submenu.....	124
4.4.7	Video Configuration Submenu.....	125
4.5	Security Menu.....	126
4.6	Power Menu .....	127
4.6.1	APM Submenu .....	128
4.6.2	ACPI Submenu .....	129
4.7	Boot Menu .....	130
4.7.1	Boot Device Priority Submenu.....	131
4.7.2	Hard Disk Drives Submenu .....	132
4.7.3	Removable Devices Submenu .....	132
4.7.4	ATAPI CDROM Drives Submenu .....	133
4.8	Exit Menu .....	133

## 5 Error Messages and Beep Codes

5.1	BIOS Error Messages.....	135
5.2	Port 80h POST Codes.....	137
5.3	Bus Initialization Checkpoints .....	141
5.4	Speaker.....	142
5.5	BIOS Beep Codes .....	143
5.6	Diagnostic LEDs (Optional).....	144

## Figures

1.	Location of Universal Board Designator.....	13
2.	Board Components.....	16
3.	Block Diagram for the D815EEA2 Board .....	17
4.	Block Diagram for the D815EPEA2 Board .....	18
5.	Intel 815E Chipset Block Diagram .....	26
6.	USB Port Configurations.....	29
7.	Intel 815EP Chipset Block Diagram .....	31
8.	USB Port Configurations.....	34
9.	Block Diagram of Audio Subsystem.....	43
10.	ICH2 and CNR Signal Interface .....	47
11.	Using the Wake on LAN Technology Connector .....	54
12.	Location of Standby Power Indicator LED.....	55
13.	Back Panel Connectors .....	64
14.	Audio, Video, Power, and Hardware Control Connectors.....	69
15.	Add-in Board and Peripheral Interface Connectors.....	73
16.	External I/O Connectors .....	78

17.	Locations of the Jumper Blocks .....	82
18.	Board Dimensions .....	84
19.	I/O Shield Dimensions (for D815EEA2 Universal Boards with Onboard LAN Subsystem) .....	86
20.	I/O Shield Dimensions (for D815EPEA2 Universal Boards with Onboard LAN Subsystem) .....	87
21.	I/O Shield Dimensions (for D815EPEA2 Universal Boards without Onboard LAN Subsystem).....	88
22.	I/O Shield Dimensions (for D815EEA2 Boards with Onboard LAN Subsystem) .....	89
23.	I/O Shield Dimensions (for D815EPEA2 Boards with Onboard LAN Subsystem).....	90
24.	I/O Shield Dimensions (for D815EPEA2 Boards without Onboard LAN Subsystem) .....	91
25.	Localized High Temperature Zones .....	96
26.	Diagnostic LEDs .....	144

**Tables**

1.	Summary of Board Differences .....	12
2.	Feature Summary .....	14
3.	Manufacturing Options.....	15
4.	Specifications .....	20
5.	Supported Processors .....	23
6.	Supported Memory Configurations .....	25
7.	Supported Graphics Refresh Frequencies .....	39
8.	LAN Connector LED States .....	45
9.	Effects of Pressing the Power Switch .....	49
10.	Power States and Targeted System Power .....	50
11.	Wake Up Devices and Events .....	51
12.	Fan Connector Descriptions .....	53
13.	System Memory Map.....	57
14.	I/O Map.....	58
15.	DMA Channels .....	60
16.	PCI Configuration Space Map .....	60
17.	Interrupts .....	61
18.	PCI Interrupt Routing Map .....	62
19.	Overcurrent Protection for Back Panel Connectors.....	65
20.	PS/2 Mouse/Keyboard Connectors.....	65
21.	USB Connectors.....	65
22.	VGA Port Connector (Present Only on D815EEA2 Boards).....	65
23.	Parallel Port Connector.....	66
24.	Serial Port A Connector .....	66
25.	LAN Connector (Optional) .....	67
26.	Mic In Connector .....	67
27.	Audio Line Out Connector.....	67
28.	Audio Line In Connector .....	67
29.	Auxiliary Line In Connector (J6B4).....	70
30.	Front Panel Audio Connector (J6B2) (Optional).....	70
31.	ATAPI CD-ROM Connector (J6B3).....	70
32.	Digital Video Out Connector (J5C1) (Optional; present only on D815EEA2 boards) .....	71



33.	Processor Fan Connector (J1B1).....	71
34.	Power Connector (J4H1) .....	71
35.	Chassis Fan Connector J4G1 (Optional) .....	72
36.	System Fan Connector (J9H1) .....	72
37.	Chassis Intrusion Connector (J9H3) (Optional).....	72
38.	Wake on LAN Technology Connector (J9G1) (Optional).....	72
39.	CNR Connector (J11B1) (Optional) .....	74
40.	PCI Bus Connectors (J7B1, J8B2, J9B2, J9B1, and J10B1) .....	75
41.	AGP Universal Connector (J6C1) .....	76
42.	Diskette Drive Connector (J6H2) .....	77
43.	IDE Connectors (J6H1, Primary and J6G2, Secondary) .....	77
44.	Serial Port B Connector (J8H1) .....	79
45.	Front Panel USB Connector (J8F1) (Optional).....	79
46.	Auxiliary Front Panel Power LED Connector (J9H2).....	79
47.	SCSI LED Connector (J8H2) .....	79
48.	Front Panel Connector (J9H3) .....	80
49.	States for a Single-Colored Power LED.....	81
50.	States for a Dual-Colored Power LED .....	81
51.	Front Panel Audio Connector / Jumper Block (J6B2) .....	83
52.	BIOS Setup Configuration Jumper Settings (J9G2) .....	83
53.	Power Usage for a D815EEA2 Board with Onboard LAN .....	93
54.	Power Usage for a D815EPEA2 Board with Add-in Graphics Card, without Onboard LAN .....	93
55.	Standby Current Requirements .....	94
56.	Thermal Considerations for Components.....	97
57.	D815EEA2 and D815EPEA2 Board Environmental Specifications .....	98
58.	Safety Regulations .....	99
59.	EMC Regulations.....	99
60.	Supervisor and User Password Functions .....	109
61.	BIOS Setup Program Menu Bar.....	111
62.	BIOS Setup Program Function Keys.....	112
63.	Maintenance Menu .....	112
64.	Extended Configuration Submenu .....	113
65.	Main Menu.....	114
66.	Advanced Menu.....	115
67.	PCI Configuration Submenu .....	116
68.	Boot Configuration Submenu.....	117
69.	Peripheral Configuration Submenu .....	118
70.	IDE Configuration Submenu .....	120
71.	Primary/Secondary IDE Master/Slave Submenus.....	121
72.	Diskette Configuration Submenu .....	123
73.	Event Log Configuration Submenu .....	124
74.	Video Configuration Submenu .....	125
75.	Security Menu.....	126
76.	Power Menu .....	127
77.	APM Submenu .....	128
78.	ACPI Submenu.....	129
79.	Boot Menu .....	130
80.	Boot Device Priority Submenu .....	131

81.	Hard Disk Drives Submenu.....	132
82.	Removeable Devices Submenu.....	132
83.	ATAPI CDROM Drives Submenu.....	133
84.	Exit Menu .....	133
85.	BIOS Error Messages.....	135
86.	Uncompressed INIT Code Checkpoints.....	137
87.	Boot Block Recovery Code Checkpoints.....	137
88.	Runtime Code Uncompressed in F000 Shadow RAM.....	138
89.	Bus Initialization Checkpoints .....	141
90.	Upper Nibble High Byte Functions .....	141
91.	Lower Nibble High Byte Functions .....	142
92.	Beep Codes.....	143
93.	Diagnostic LED Codes.....	145

# 1 Product Description

---

## What This Chapter Contains

1.1	Board Differences.....	12
1.2	Overview .....	14
1.3	Online Support.....	19
1.4	Operating System Support.....	19
1.5	Design Specifications .....	20
1.6	Processor .....	23
1.7	System Memory.....	24
1.8	Chipsets .....	26
1.9	I/O Controller .....	36
1.10	Graphics Subsystems.....	38
1.11	Audio Subsystem.....	43
1.12	LAN Subsystem (Optional) .....	45
1.13	Hardware Management Subsystem.....	46
1.14	CNR Connector (Optional).....	47
1.15	Power Management.....	48

## 1.1 Board Differences

### 1.1.1 Feature Level Differences

This TPS describes these Intel® Desktop boards: D815EEA2 and D815EPEA2. Table 1 summarizes the differences between these boards.

**Table 1. Summary of Board Differences**

<b>D815EEA2</b>	<ul style="list-style-type: none"> <li>• Includes the Intel® 815E Chipset, which includes the Intel® 82815 Graphics and Memory Controller Hub (GMCH)</li> <li>• Provides these video features: AGP universal connector and an optional Digital Video Output (DVO) connector</li> </ul>
<b>D815EPEA2</b>	<ul style="list-style-type: none"> <li>• Includes the Intel® 815EP Chipset, which includes the Intel® 82815EP Memory Controller Hub (MCH)</li> <li>• Provides this video feature: AGP universal connector</li> </ul>

## 1.1.2 Identifying Universal Boards

The Universal versions of the D815EEA2 and D815EPEA2 can be identified by an uppercase “U” on the silkscreen of the board. Figure 1 shows the location of the Universal board designer.

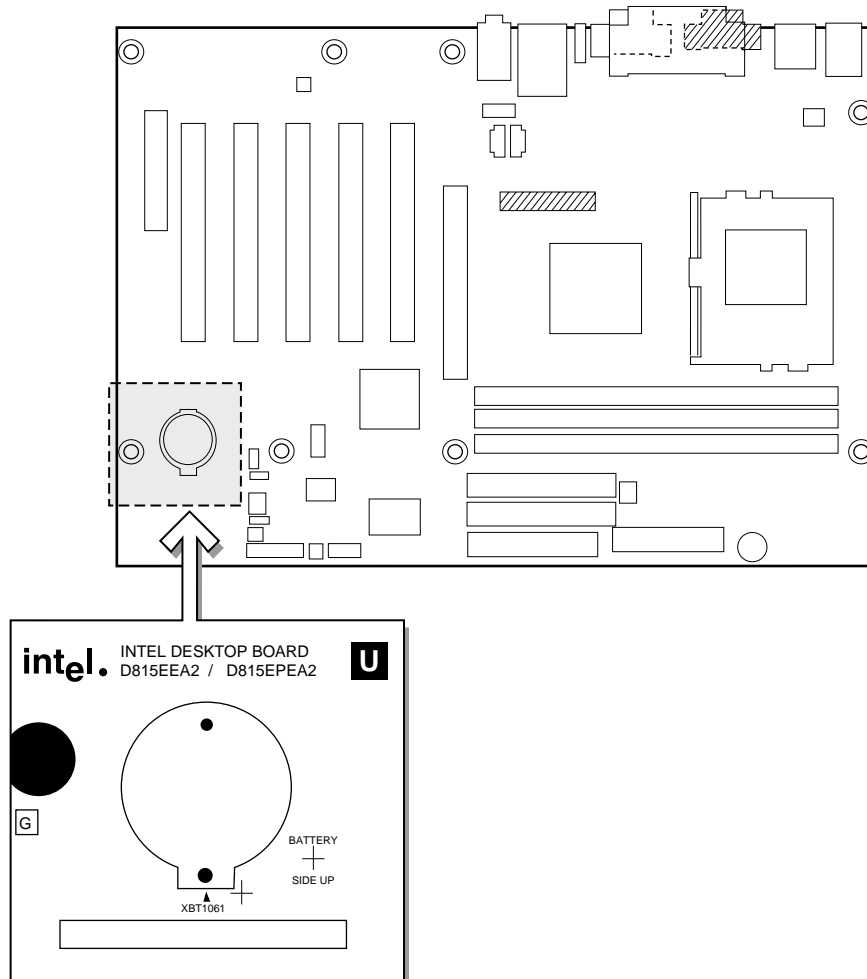

OM12012

**Figure 1. Location of Universal Board Designer**

### ⇒ NOTE

*Unless otherwise stated, all information pertaining to standard boards also apply to Universal boards.*

## 1.2 Overview

### 1.2.1 Feature Summary

Table 2 summarizes the D815EEA2 and D815EPEA2 boards' major features.

**Table 2. Feature Summary**

<b>Form Factor</b>	ATX (11.55 inches by 8.20 inches)
<b>Processor</b>	Support for either an Intel® Pentium® III processor in a Flip Chip Pin Grid Array (FC-PGA) package or an Intel® Celeron™ processor in an FC-PGA package
<b>Memory</b>	<ul style="list-style-type: none"> <li>• Three 168-pin SDRAM Dual Inline Memory Module (DIMM) sockets</li> <li>• Support for up to 512 MB system memory</li> <li>• Support for single-sided or double-sided DIMMs</li> </ul>
<b>Chipsets</b>	<ul style="list-style-type: none"> <li>• The D815EEA2 board includes the Intel 815E Chipset, consisting of: <ul style="list-style-type: none"> <li>— Intel 82815 Graphics and Memory Controller Hub (GMCH)</li> <li>— Intel® 82801BA I/O Controller Hub (ICH2)</li> <li>— SST 49LF004A 4 Mbit Firmware Hub (FWH)</li> </ul> </li> <li>• The D815EPEA2 board includes the Intel 815EP Chipset, consisting of: <ul style="list-style-type: none"> <li>— Intel 82815EP Memory Controller Hub (MCH)</li> <li>— Intel 82801BA I/O Controller Hub (ICH2)</li> <li>— SST 49LF004A 4 Mbit Firmware Hub (FWH)</li> </ul> </li> </ul>
<b>I/O Control</b>	SMSC LPC47M132 LPC bus I/O controller
<b>Video</b>	<ul style="list-style-type: none"> <li>• The D815EEA2 board includes: <ul style="list-style-type: none"> <li>— Intel 82815 integrated graphics support</li> <li>— AGP universal connector supporting 1x, 2x, and 4x AGP cards or a Graphics Performance Accelerator (GPA)</li> </ul> </li> <li>• The D815EPEA2 board includes an AGP universal connector supporting 1x, 2x, and 4x AGP cards</li> </ul>
<b>Audio</b>	<ul style="list-style-type: none"> <li>• Intel 82801BA ICH2 digital controller (AC link output)</li> <li>• Analog Devices AD1885 Audio Codec</li> </ul>
<b>Peripheral Interfaces</b>	<ul style="list-style-type: none"> <li>• Four Universal Serial Bus (USB) ports</li> <li>• Two serial ports</li> <li>• One parallel port</li> <li>• Two IDE interfaces with Ultra DMA, ATA-66/100 support</li> <li>• One diskette drive interface</li> <li>• PS/2<sup>†</sup> keyboard and mouse ports</li> </ul>
<b>Expansion Capabilities</b>	<ul style="list-style-type: none"> <li>• Five PCI bus add-in card connectors (SMBus routed to PCI bus connector 2)</li> <li>• One AGP universal connector</li> </ul>
<b>BIOS</b>	<ul style="list-style-type: none"> <li>• Intel/AMI BIOS (stored in an SST 49LF004A 4 Mbit FWH)</li> <li>• Support for Advanced Power Management (APM), Advanced Configuration and Power Interface (ACPI), Plug and Play, and SMBIOS</li> </ul>

continued

**Table 2. Feature Summary** (continued)

<b>Instantly Available PC</b>	<ul style="list-style-type: none"> <li>• Support for <i>PCI Local Bus Specification Revision 2.2</i></li> <li>• Suspend to RAM support</li> <li>• Wake on PS/2 keyboard and USB ports</li> </ul>
<b>Hardware Monitor Subsystem</b>	<ul style="list-style-type: none"> <li>• Voltage sense to detect out of range values</li> <li>• Two fan sense inputs used to monitor fan activity</li> </ul>
<b>SCSI LED Connector</b>	Allows add-in SCSI host bus adapters to use the same LED as the onboard I/O controller

For information about	Refer to
The board's compliance level with APM, ACPI, Plug and Play, and SMBIOS	Table 4, page 20

## 1.2.2 Manufacturing Options

Table 3 describes the D815EEA2 and D815EPEA2 boards' manufacturing options. Not every manufacturing option is available in all marketing channels. Please contact your Intel representative to determine which manufacturing options are available to you.

**Table 3. Manufacturing Options**

<b>Chassis fan connector</b>	Connector for an additional chassis fan
<b>Chassis Intrusion Connector</b>	Detects chassis intrusion
<b>Communication and Networking Riser (CNR) Connector</b>	One CNR connector (slot shared with PCI bus connector 3)
<b>Diagnostic LEDs</b>	Four dual-color LEDs on the back panel
<b>Front Panel Audio Connector</b>	Routes mic in and line out to the front panel
<b>Front Panel USB Connector</b>	Provides access to two additional USB ports, routed through the optional SMSC LPC47M142 I/O controller
<b>I/O Control</b>	SMSC LPC47M142 LPC bus I/O controller
<b>LAN Subsystem</b>	Intel® 82562ET 10/100 Mbit/sec Platform LAN Connect (PLC) device
<b>Video</b>	Digital Video Output (DVO) connector
<b>Wake on LAN<sup>†</sup> Technology Connector</b>	Support for system wake up using an add-in network interface card with remote wake up capability

## 1.2.3 Board Layout

Figure 2 shows the location of the major components on the D815EEA2 and D815EPEA2 boards.

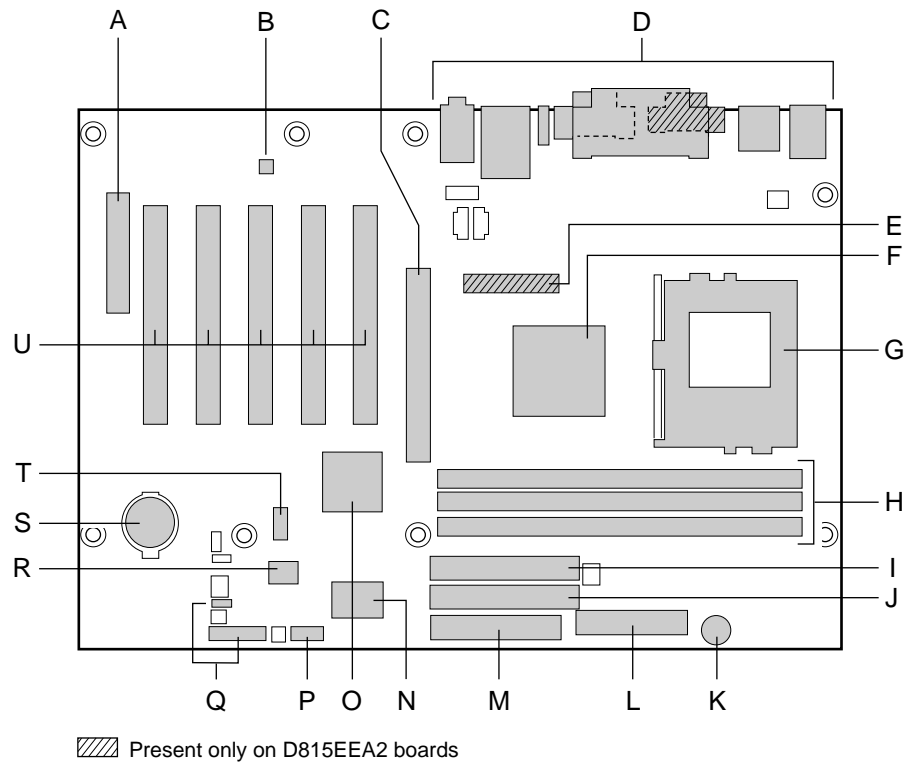

OM11461

- |  |   |
|--|---|
| <p>A Communication and Networking Riser (CNR) connector (optional)</p> <p>B AD1885 audio codec</p> <p>C AGP universal connector</p> <p>D Back panel connectors</p> <p>E DVO connector (optional)</p> <p>F</p> <ul style="list-style-type: none"> <li>• Intel 82815 Graphics and Memory Controller Hub (GMCH) (D815EEA2 boards)</li> <li>• Intel 82815EP Memory Controller Hub (MCH) (D815EPEA2 boards)</li> </ul> <p>G Processor socket</p> <p>H DIMM sockets</p> <p>I Secondary IDE connector</p> | <p>J Primary IDE connector</p> <p>K Speaker</p> <p>L Power connector</p> <p>M Diskette drive connector</p> <p>N SMC LPC47M132 I/O Controller</p> <p>O Intel 82801BA I/O Controller Hub (ICH2)</p> <p>P Serial port B connector</p> <p>Q Front panel connectors</p> <p>R SST 49LF004A 4 Mbit Firmware Hub (FWH)</p> <p>S Battery</p> <p>T Front panel USB connector (optional)</p> <p>U PCI bus add-in card connectors</p> |
|--|---|

**Figure 2. Board Components**



### 1.2.4 Block Diagrams

Figure 3 is a block diagram of the major functional areas of the D815EEA2 board.

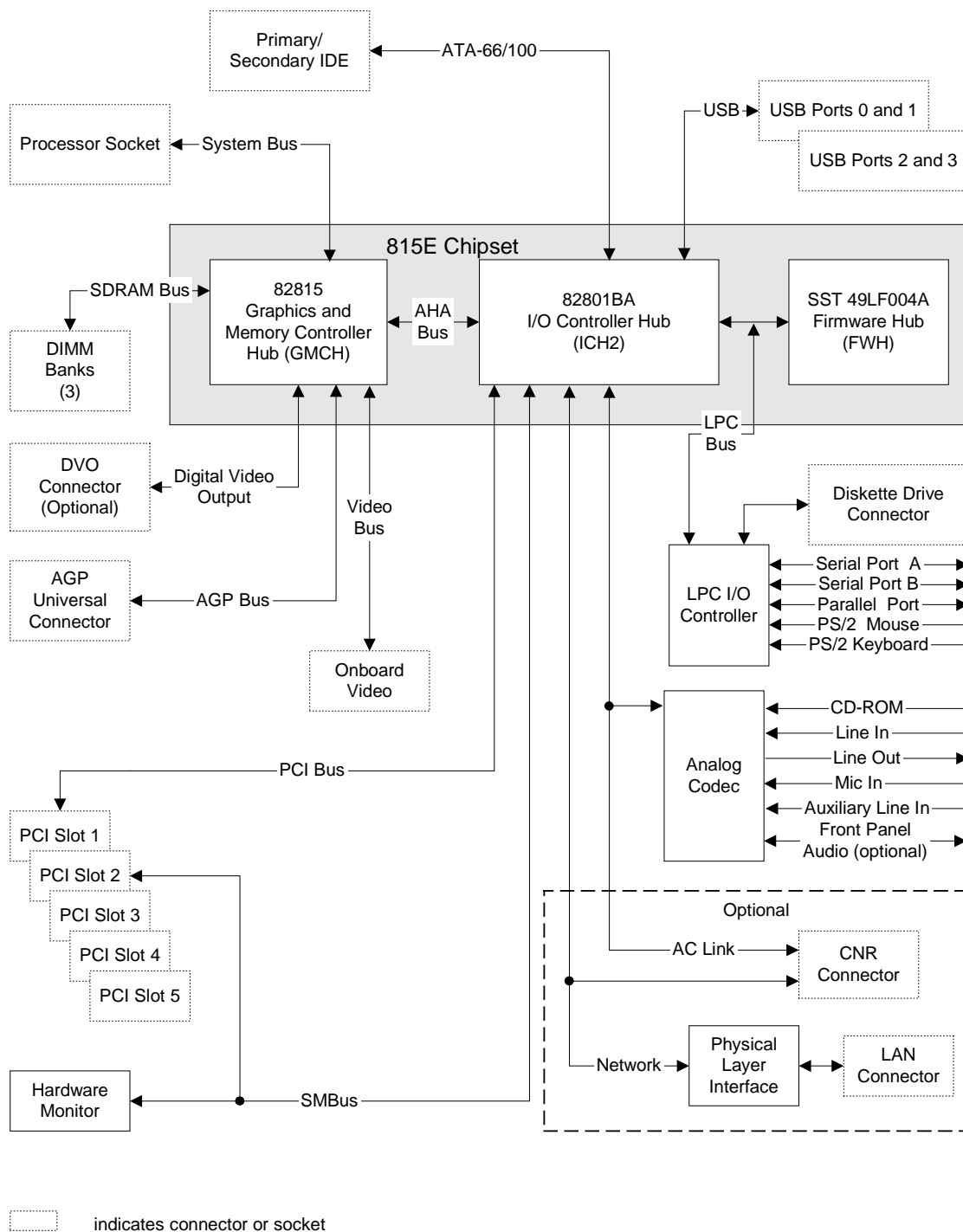

OM11889

Figure 3. Block Diagram for the D815EEA2 Board

Figure 4 is a block diagram of the major functional areas of the D815EPEA2 board.

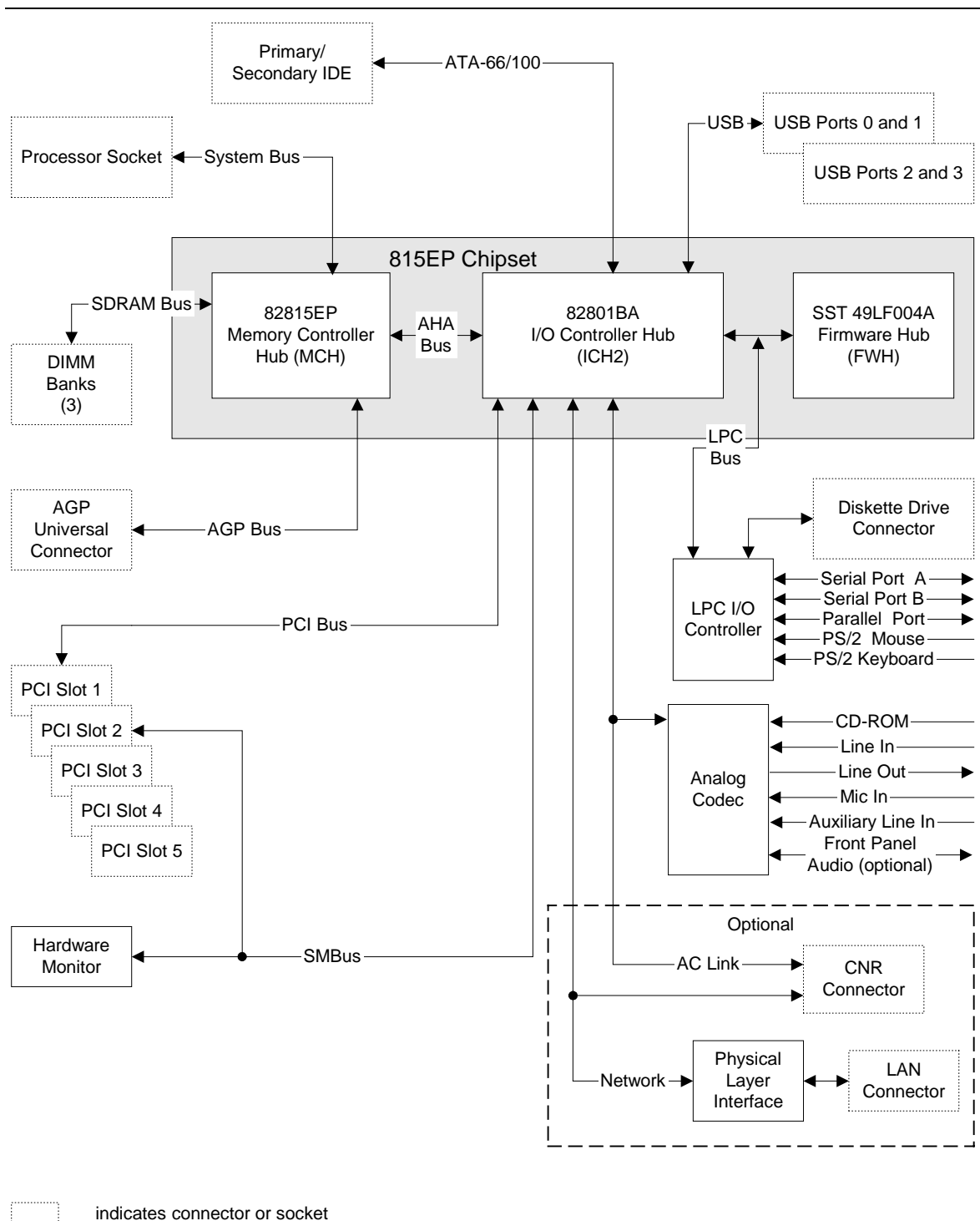

OM11890

Figure 4. Block Diagram for the D815EPEA2 Board

## 1.3 Online Support

To find information about...	Visit this World Wide Web site:
Intel's D815EEA2 and D815EPEA2 boards under "Product Info" or "Customer Support"	<a href="http://www.intel.com/design/motherbd">http://www.intel.com/design/motherbd</a> <a href="http://support.intel.com/support/motherboards/desktop">http://support.intel.com/support/motherboards/desktop</a>
Processor data sheets	<a href="http://www.intel.com/design/litcentr">http://www.intel.com/design/litcentr</a>
ICH2 addressing	<a href="http://developer.intel.com/design/chipsets/datashts">http://developer.intel.com/design/chipsets/datashts</a>
Custom splash screens	<a href="http://intel.com/design/motherbd/gen_indx.htm">http://intel.com/design/motherbd/gen_indx.htm</a>
Audio software and utilities	<a href="http://www.intel.com/design/motherbd">http://www.intel.com/design/motherbd</a>
LAN software and drivers	<a href="http://www.intel.com/design/motherbd">http://www.intel.com/design/motherbd</a>

## 1.4 Operating System Support

The D815EEA2 and D815EPEA2 boards support drivers for all of the onboard hardware and subsystems under the following operating systems:

- Windows† 98/98SE
- Windows ME
- Windows NT† 4.0
- Windows 2000

For information about	Refer to
Supported drivers	Section 1.3

### ⇒ NOTE

*Third party vendors may offer other drivers.*

## 1.5 Design Specifications

Table 4 lists the specifications applicable to the D815EEA2 and D815EPEA2 boards, except for the AIMM and GPA entries, which apply only to the D815EEA2 board.

**Table 4. Specifications**

Reference Name	Specification Title	Version, Revision Date, and Ownership	The information is available from...
AC '97	<i>Audio Codec '97</i>	Revision 2.2, September 2000, Intel Corporation.	<a href="ftp://download.intel.com/ial/scalableplatforms/ac97r22.pdf">ftp://download.intel.com/ial/scalableplatforms/ac97r22.pdf</a>
ACPI	<i>Advanced Configuration and Power Interface Specification</i>	Version 2.0, July 27, 2000, Compaq Computer Corporation, Intel Corporation, Microsoft Corporation, Phoenix Technologies Limited, and Toshiba Corporation.	<a href="http://www.teleport.com/~acpi/">http://www.teleport.com/~acpi/</a>
AGP	<i>Accelerated Graphics Port Interface Specification</i>	Revision 2.0, May 4, 1998, Intel Corporation.	<a href="http://www.agpforum.org/">http://www.agpforum.org/</a>
AIMM (for Graphics Performance Accelerator cards)	<i>AGP Inline Memory Module</i>	Revision 1.0, April 2000, Intel Corporation.	<a href="http://developer.intel.com/technology/memory/aimm/298177.htm">http://developer.intel.com/technology/memory/aimm/298177.htm</a>
AMI BIOS	<i>American Megatrends BIOS Specification</i>	AMIBIOS 99, 1999, American Megatrends, Inc.	<a href="http://www.amij.com/amibios/bios.platforms.desktop.html">http://www.amij.com/amibios/bios.platforms.desktop.html</a>
APM	<i>Advanced Power Management BIOS Interface Specification</i>	Version 1.2, February 1996, Intel Corporation and Microsoft Corporation.	<a href="http://www.microsoft.com/hwdev/busbios/amp_12.htm">http://www.microsoft.com/hwdev/busbios/amp_12.htm</a>
ATA/ ATAPI-5	<i>Information Technology - AT Attachment with Packet Interface - 5 (ATA/ATAPI-5)</i>	Revision 3, February 29, 2000, Contact: T13 Chair, Seagate Technology.	<a href="http://www.t13.org">http://www.t13.org</a>
ATX	<i>ATX Specification</i>	Version 2.03, December 1998, Intel Corporation.	<a href="http://www.formfactors.org/developer/specs/atx/atxspecs.htm">http://www.formfactors.org/developer/specs/atx/atxspecs.htm</a>
CNR	<i>Communication and Network Riser (CNR) Specification</i>	Revision 1.1, October 18, 2000, Intel Corporation.	<a href="http://developer.intel.com/technology/cnr/index.htm">http://developer.intel.com/technology/cnr/index.htm</a>

continued

**Table 4. Specifications** (continued)

Reference Name	Specification Title	Version, Revision Date and Ownership	The information is available from...
DVI	<i>Digital Visual Interface DVI</i>	Revision 1.0, April 2, 1999, Intel Corporation, Silicon Image Incorporated, Compaq Computer Corporation, Fujitsu Limited, Hewlett-Packard Company, and NEC Corporation.	<a href="http://www.ddwg.org/downloads.html">http://www.ddwg.org/downloads.html</a>
EPP	<i>IEEE Std 1284.1-1997</i> (Enhanced Parallel Port)	Version 1.7, 1997, Institute of Electrical and Electronic Engineers.	<a href="http://standards.ieee.org/reading/ieee/std_public/description/busarch/1284.1-1997_desc.html">http://standards.ieee.org/reading/ieee/std_public/description/busarch/1284.1-1997_desc.html</a>
EI Torito	<i>Bootable CD-ROM Format Specification</i>	Version 1.0, January 25, 1995, Phoenix Technologies Limited and International Business Machines Corporation.	<a href="http://www.phoenix.com/PlatSS/products/specs.html">http://www.phoenix.com/PlatSS/products/specs.html</a>
GPA (see AIMM)			
LPC	<i>Low Pin Count Interface Specification</i>	Version 1.0, September 29, 1997, Intel Corporation.	<a href="http://www.intel.com/design/chipsets/industry/lpc.htm">http://www.intel.com/design/chipsets/industry/lpc.htm</a>
PCI	<i>PCI Local Bus Specification</i>	Version 2.2, December 18, 1998, PCI Special Interest Group.	<a href="http://www.pcisig.com/">http://www.pcisig.com/</a>
	<i>PCI Bus Power Management Interface Specification</i>	Version 1.1, December 18, 1998, PCI Special Interest Group.	<a href="http://www.pcisig.com/">http://www.pcisig.com/</a>
Plug and Play	<i>Plug and Play BIOS Specification</i>	Version 1.0a, May 5, 1994, Compaq Computer Corporation, Phoenix Technologies Limited, and Intel Corporation.	<a href="http://www.microsoft.com/hwdev/respec/pnpspecs.htm">http://www.microsoft.com/hwdev/respec/pnpspecs.htm</a>

continued

**Table 4. Specifications (continued)**

<b>Reference Name</b>	<b>Specification Title</b>	<b>Version, Revision Date and Ownership</b>	<b>The information is available from...</b>
SDRAM	<i>PC SDRAM Unbuffered DIMM Specification</i>	Revision 1.0, February 1998, Intel Corporation.	<a href="http://www.intel.com/technology/memory">http://www.intel.com/technology/memory</a>
	<i>PC SDRAM Specification</i>	Revision 1.7, November 1999, Intel Corporation.	<a href="http://www.intel.com/technology/memory">http://www.intel.com/technology/memory</a>
	<i>PC Serial Presence Detect (SPD) Specification</i>	Revision 1.2B, November 1999, Intel Corporation.	<a href="http://www.intel.com/technology/memory">http://www.intel.com/technology/memory</a>
SMBIOS	<i>System Management BIOS</i>	Version 2.3.1, March 16, 1999, American Megatrends Incorporated, Award Software International Incorporated, Compaq Computer Corporation, Dell Computer Corporation, Hewlett-Packard Company, Intel Corporation, International Business Machines Corporation, Phoenix Technologies Limited, and SystemSoft Corporation.	<a href="http://developer.intel.com/ial/wfm/design/smbios">http://developer.intel.com/ial/wfm/design/smbios</a>
UHCI	<i>Universal Host Controller Interface Design Guide</i>	Revision 1.1, March 1996, Intel Corporation.	<a href="http://www.usb.org/developers">http://www.usb.org/developers</a>
USB	<i>Universal Serial Bus Specification</i>	Version 1.1, September 23, 1998, Compaq Computer Corporation, Intel Corporation, Microsoft Corporation, and NEC Corporation.	<a href="http://www.usb.org/developers">http://www.usb.org/developers</a>
WfM	<i>Wired for Management Baseline</i>	Version 2.0, December 18, 1998, Intel Corporation.	<a href="http://developer.intel.com/ial/WfM/wfmspecs.htm">http://developer.intel.com/ial/WfM/wfmspecs.htm</a>

## 1.6 Processor



### CAUTION

*Use only the processors listed below. Use of unsupported processors can damage the board, the processor, and the power supply. See the Intel Desktop D815EEA2/D815EPEA2 Specification Update for the most up-to-date list of supported processors for the D815EEA2 and D815EPEA2 boards.*

The D815EEA2 and D815EPEA2 boards both support a single Pentium III or Celeron processor. The system bus frequency is automatically selected. The D815EEA2 and D815EPEA2 boards support the processors listed in Table 5.

**Table 5. Supported Processors**

Type	Designation	System Bus Frequency	L2 Cache Size
Pentium III processor in an FC-PGA package	533EB, 600EB, 667, 733, 800B, 866, and 933 MHz 1.0 GHz	133 MHz	256 KB
	500E, 550E, 600E, 650, 700, 750, 800, and 850 MHz	100 MHz	256 KB
Celeron processor in an FC-PGA package	800 and 850 MHz	100 MHz	128 KB
	533A, 566, 600, 633, 667, 700, 733, and 766 MHz	66 MHz	128 KB

All supported onboard memory can be cached, up to the cachability limit of the processor. See the processor's data sheet for cachability limits.

For information about	Refer to
Product information on supported processors	Section 1.3, page 19
Processor data sheets	Section 1.3, page 19

## 1.7 System Memory



### CAUTION

*Before installing or removing memory, make sure that AC power is disconnected by unplugging the power cord from the computer. Failure to do so could damage the memory and the board.*

### NOTE

*Remove the AGP video card before installing or upgrading memory to avoid interference with the memory retention mechanism.*

### NOTE

*To be fully compliant with all applicable Intel® SDRAM memory specifications, the board should be populated with DIMMs that support the Serial Presence Detect (SPD) data structure. This allows the BIOS to read the SPD data and program the chipset to accurately configure memory settings for optimum performance. If non-SPD memory is installed, the BIOS will attempt to correctly configure the memory settings, but performance and reliability may be impacted or the DIMMs may not function under the determined frequency.*

The D815EEA2 and D815EPEA2 boards both have three DIMM sockets and support the following memory features:

- 3.3 V (only) 168-pin SDRAM DIMMs with gold-plated contacts
- Unbuffered single-sided or double-sided DIMMs
- Maximum total system memory: 512 MB; minimum total system memory: 64 MB
- 133 MHz SDRAM or 100 MHz SDRAM
- Serial Presence Detect (SPD) and non-SPD memory
- Non-ECC and ECC DIMMs (ECC DIMMs will operate in non-ECC mode only)
- Suspend to RAM

When installing memory, note the following:

- Non-SPD DIMMs will always revert to a 100 MHz with 3-3-3 timing SDRAM bus.
- Mixing Non-SPD DIMMs with SPD DIMMs will always revert to a 100 MHz with 3-3-3 timing SDRAM bus.
- The BIOS will not initialize installed memory above 512 MB.
- Mixed memory speed configurations (133 and 100 MHz) will default to 100 MHz.
- 133 MHz SDRAM operation requires a 133 MHz system bus frequency processor.
- The board should be populated with no more than four rows of 133 MHz SDRAM (two double-sided or one double-sided plus two single-sided DIMMs).
- 100 MHz SDRAM may be populated with six rows of SDRAM (three double-sided DIMMs).

### NOTE

*At boot, the BIOS displays a message indicating that any installed memory above 512 MB has not been initialized.*



## ⇒ NOTE

If more than four rows of 133 MHz SDRAM are populated, the BIOS will display a message indicating that it will initialize installed memory up to 512 MB at 100 MHz.

For information about	Refer to
Obtaining the <i>PC Serial Presence Detect (SPD) Specification</i>	Table 4, page 19

Table 6 lists the supported DIMM configurations.

**Table 6. Supported Memory Configurations**

DIMM Capacity	Number of Sides	SDRAM Density	SDRAM Organization Front-side/Back-side	Number of SDRAM devices
32 MB	DS	16 Mbit	2 M x 8/2 M x 8	16 (Note 1)
32 MB	SS	64 Mbit	4 M x 16/empty	4
48 MB	DS	64/16 Mbit	4 M x 16/2 M x 8	12 (Notes 1 and 2)
64 MB	DS	64 Mbit	4 M x 16/4 M x 16	8
64 MB	SS	64 Mbit	8 M x 8/empty	8
64 MB	SS	128 Mbit	8 M x 16/empty	4
96 MB	DS	64 Mbit	8 M x 8/4 M x 16	12 (Notes 1 and 2)
96 MB	DS	128/64 Mbit	8 M x 16/4 M x 16	8 (Notes 1 and 2)
128 MB	DS	64 Mbit	8 M x 8/8 M x 8	16 (Note 1)
128 MB	DS	128 Mbit	8 M x 16/8 M x 16	8 (Notes 1 and 2)
128 MB	SS	128 Mbit	16 M x 8/empty	8
128 MB	SS	256 Mbit	16 M x 16/empty	4
192 MB	DS	128 Mbit	16 M x 8/8 M x 16	12 (Notes 1 and 2)
192 MB	DS	128/64 Mbit	16 M x 8/8 M x 8	16 (Notes 1 and 2)
256 MB	DS	128 Mbit	16 M x 8/16 M x 8	16 (Notes 1 and 2)
256 MB	DS	256 Mbit	16 M x 16/16 M x 16	8 (Notes 1 and 2)
256 MB	SS	256 Mbit	32 M x 8/empty	8
512 MB	DS	256 Mbit	32 M x 8/32 M x 8	16 (Notes 1 and 2)

Notes:

1. If the number of SDRAM devices is greater than nine, the DIMM will be double sided.
2. Front side population/back side population indicated for SDRAM density and SDRAM organization.
3. In the second column, "DS" refers to double-sided memory modules (containing two rows of SDRAM) and "SS" refers to single-sided memory modules (containing one row of SDRAM).

## 1.8 Chipsets

This section describes the chipsets used by the D815EEA2 and D815EPEA2 boards:

- The D815EEA2 board uses the Intel 815E Chipset, described below.
- The D815EPEA2 board uses the Intel 815EP Chipset, described in Section 1.8.2, beginning on page 31.

### 1.8.1 Intel® 815E Chipset

The Intel 815E chipset consists of the following devices:

- 82815 Graphics and Memory Controller Hub (GMCH) with Accelerated Hub Architecture (AHA) bus
- 82801BA I/O Controller Hub (ICH2) with AHA bus
- SST 49LF004A Firmware Hub (FWH)

The GMCH is a centralized controller for the system bus, the memory bus, the AGP bus, and the AHA bus. The ICH2 is a centralized controller for the board's I/O paths. The FWH provides the nonvolatile storage of the BIOS.

The Intel 815E chipset provides the interfaces shown in Figure 5.

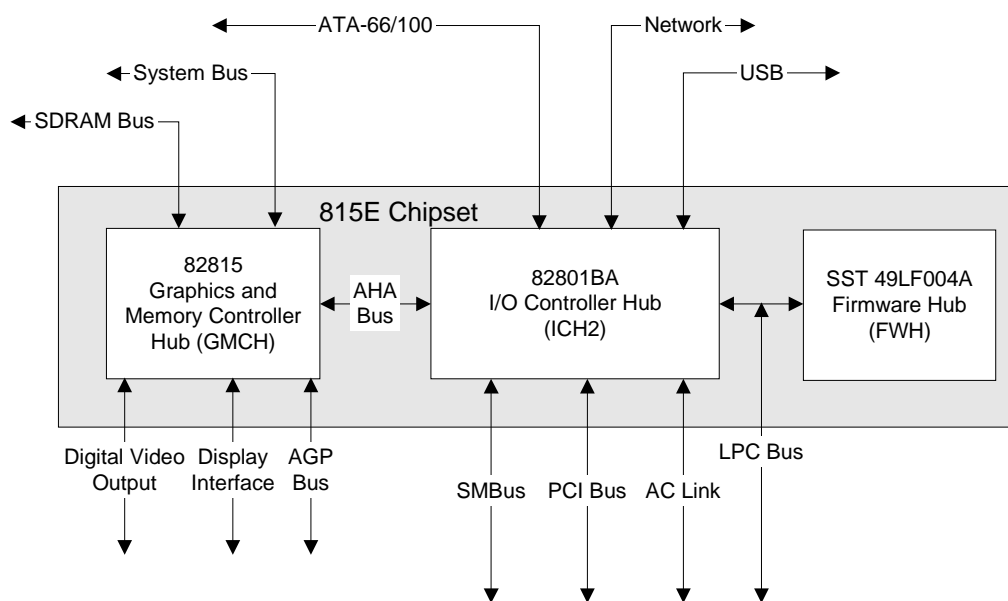

OM11891

**Figure 5. Intel 815E Chipset Block Diagram**

For information about	Refer to
The Intel 815E chipset	<a href="http://developer.intel.com/design/chipsets/815e">http://developer.intel.com/design/chipsets/815e</a>
The resources used by the chipset	Chapter 2
The chipset's compliance with ACPI, APM, and AC '97	Table 4, page 19

### 1.8.1.1 Intel® 82815 Graphics and Memory Controller Hub (GMCH)

The GMCH provides the following:

- An integrated Synchronous DRAM memory controller with autodetection of SDRAM
- An interface for a single AGP device or a Graphics Performance Accelerator (GPA) card
- An interface for an optional digital video output (DVO) connector for a flat panel, digital CRT, or TV-out
- Support for ACPI Rev. 2.0 and APM Rev. 1.2 compliant power management

### 1.8.1.2 Intel® 82801BA I/O Controller Hub (ICH2)

The ICH2 provides the following:

- 33 MHz PCI bus interface
- Support for up to six PCI master devices
- Low Pin Count (LPC) interface that supports an LPC-compatible I/O controller
- Support for two Master/DMA devices
- Integrated IDE controller that supports Ultra DMA (33 MB/sec) and ATA-66/100 mode (66 MB/sec, 100 MB/sec)
- Integrated LAN Media Access Controller
- Universal Serial Bus interface with two USB controllers providing four ports in a UHCI Implementation (additional USB ports provided with the optional SMSC LPC47M142 I/O controller)
- Power management logic for ACPI Rev. 1.0b compliance
- System Management Bus (SMBus clock and data lines also routed to PCI bus connector 2)
- Real-time clock with 256-byte battery-backed CMOS RAM
- AC '97 digital link for audio codec, including:
  - AC '97 2.1 compliance
  - Logic for PCM in, PCM out, and mic input
  - PCI functions for audio
  - Communication and Network Riser (CNR) interface

#### 1.8.1.2.1 IDE Interfaces

The ICH2's IDE controller has two independent bus-mastering IDE interfaces that can be independently enabled. The IDE interfaces support the following modes:

- Programmed I/O (PIO): CPU controls data transfer.
- 8237-style DMA: DMA offloads the CPU, supporting transfer rates of up to 16 MB/sec.
- Ultra DMA: DMA protocol on IDE bus supporting host and target throttling and transfer rates of up to 33 MB/sec.
- ATA-66: DMA protocol on IDE bus supporting host and target throttling and transfer rates of up to 66 MB/sec. ATA-66 protocol is similar to Ultra DMA and is device driver compatible.
- ATA-100: DMA protocol on IDE bus allows host and target throttling. The ICH2 ATA-100 logic can achieve read transfer rates up to 100 MB/sec and write transfer rates up to 88 MB/sec.

#### ⇒ NOTE

*ATA-66 and ATA-100 are faster timings and require a specialized cable to reduce reflections, noise, and inductive coupling.*

The IDE interfaces also support ATAPI devices (such as CD-ROM drives) and ATA devices using the transfer modes listed in Table 71 on page 121.

The BIOS supports Logical Block Addressing (LBA) and Extended Cylinder Head Sector (ECHS) translation modes. The drive reports the transfer rate and translation mode to the BIOS.

The D815EEA2 board supports Laser Servo (LS-120) diskette technology through its IDE interfaces. The LS-120 drive can be configured as a boot device by setting the BIOS Setup program's Boot menu to one of the following:

- ARMD-FDD (ATAPI removable media device – floppy disk drive)
- ARMD-HDD (ATAPI removable media device – hard disk drive)

For information about	Refer to
The location of the IDE connectors	Figure 15, page 73
The signal names of the IDE connectors	Table 43, page 77
BIOS Setup program's Boot menu	Section 4.7, page 130

### 1.8.1.2.2 USB

The ICH2 contains two separate USB controllers. The D815EEA2 board has four USB ports; one USB peripheral can be connected to each port. For more than four USB devices, an external hub can be connected to any of the ports. The D815EEA2 board fully supports the Universal Hub Controller Interface (UHCI).

In the standard configuration, the D815EEA2 board's four USB ports are implemented with stacked back panel connectors, routed through the ICH2, as shown in Figure 6.

With the optional SMSC LPC47M142 I/O controller, the D815EEA2 board supports up to seven USB ports. The SMSC LPC47M142 I/O controller provides four ports: two ports implemented with stacked back panel connectors and two ports routed to the optional front panel USB connector at location J8F1. The ICH2 provides three ports: two ports are implemented with stacked back panel connectors and the other port is accessible through a CNR add-in card, as shown in Figure 6.

The D815EEA2 board fully supports the Universal Hub Controller Interface (UHCI).

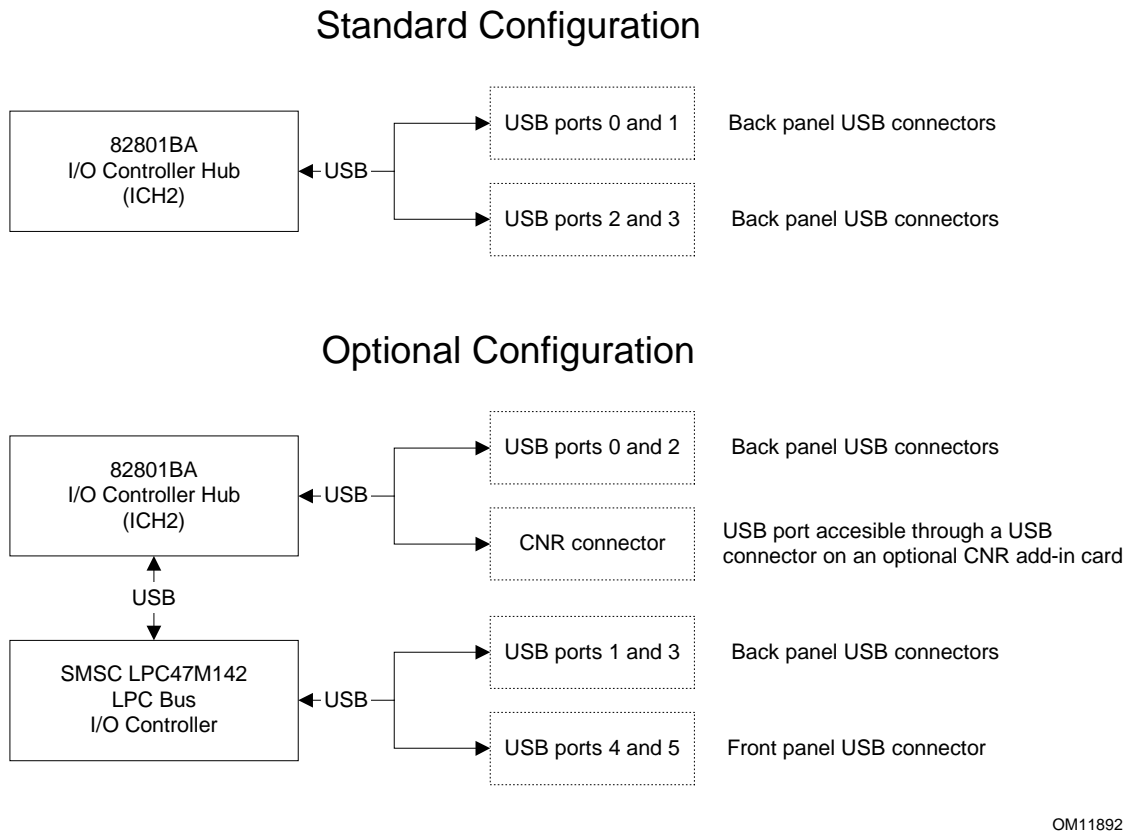

**Figure 6. USB Port Configurations**

#### ⇒ NOTE

*Computer systems that have an unshielded cable attached to a USB port may not meet FCC Class B requirements, even if no device or a low-speed USB device is attached to the cable. Use shielded cable that meets the requirements for full-speed devices.*

For information about	Refer to
The location of the USB connectors on the back panel	Figure 13, page 64
The signal names of the back panel USB connectors	Table 21, page 65
The location of the optional front panel USB connector	Figure 16, page 78
The signal names of the optional front panel USB connector	Table 45, page 79
The USB specification and UHCI	Table 4, page 20

### 1.8.1.2.3 Real-Time Clock, CMOS SRAM, and Battery

The real-time clock provides a time-of-day clock and a multicentury calendar with alarm features. The real-time clock supports 256 bytes of battery-backed CMOS SRAM in two banks that are reserved for BIOS use.

A coin-cell battery (CR2032) powers the real-time clock and CMOS memory. When the computer is not plugged into a wall socket, the battery has an estimated life of three years. When the computer is plugged in, the standby current from the power supply extends the life of the battery. The clock is accurate to  $\pm 13$  minutes/year at 25 °C with 3.3 VSB applied.

The time, date, and CMOS values can be specified in the BIOS Setup program. The CMOS values can be returned to their defaults by using the BIOS Setup program.

#### ⇒ **NOTE**

*If the battery and AC power fail, custom defaults, if previously saved, will be loaded into CMOS SRAM at power-on.*

### 1.8.1.3 SST 49LF004A 4 Mbit Firmware Hub (FWH)

The system BIOS is stored in the FWH.

## 1.8.2 Intel® 815EP Chipset

The Intel 815EP chipset consists of the following devices:

- 82815EP Memory Controller Hub (MCH) with Accelerated Hub Architecture (AHA) bus
- 82801BA I/O Controller Hub (ICH2) with AHA bus
- SST 49LF004A Firmware Hub (FWH)

The MCH is a centralized controller for the system bus, the memory bus, the AGP bus, and the AHA bus. The ICH2 is a centralized controller for the board's I/O paths. The FWH provides the nonvolatile storage of the BIOS.

The Intel 815EP chipset provides the interfaces shown in Figure 7.

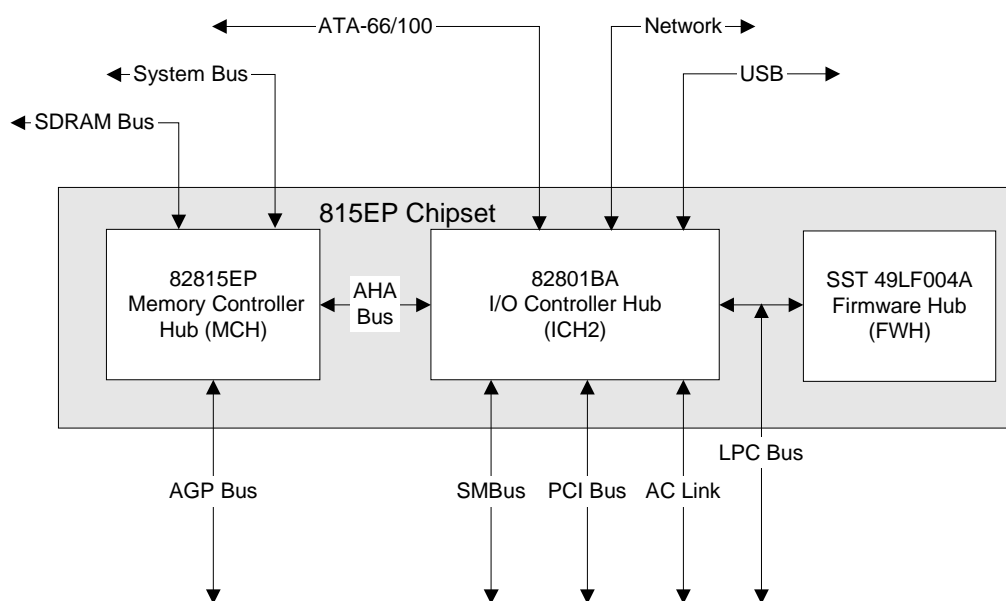

OM11318

**Figure 7. Intel 815EP Chipset Block Diagram**

For information about	Refer to
The Intel 815EP chipset	<a href="http://developer.intel.com/design/chipsets/815ep">http://developer.intel.com/design/chipsets/815ep</a>
The resources used by the chipset	Chapter 2
The chipset's compliance with ACPI, APM, and AC '97	Table 4, page 20

### 1.8.2.1 Intel® 82815EP Memory Controller Hub (MCH)

The MCH provides the following:

- An integrated Synchronous DRAM memory controller with autodetection of SDRAM
- An interface for a single AGP device
- Support for ACPI Rev. 2.0 and APM Rev. 1.2 compliant power management

### 1.8.2.2 Intel 82801BA I/O Controller Hub (ICH2)

The ICH2 provides the following:

- 33 MHz PCI bus interface
- Support for up to six PCI master devices
- Low Pin Count (LPC) interface that supports an LPC-compatible I/O controller
- Support for two Master/DMA devices
- Integrated IDE controller that supports Ultra DMA (33 MB/sec) and ATA-66/100 mode (66 MB/sec, 100 MB/sec)
- Integrated LAN Media Access Controller
- Universal Serial Bus interface with two USB controllers providing four back panel ports in a UHCI Implementation (additional USB ports provided with the optional SMSC LPC47M142 I/O controller)
- Power management logic for ACPI Rev. 1.0b compliance
- System Management Bus (SMBus clock and data lines also routed to PCI bus connector 2)
- Real-time clock with 256-byte battery-backed CMOS RAM
- AC '97 digital link for audio codec, including:
  - AC '97 2.1 compliance
  - Logic for PCM in, PCM out, and mic input
  - PCI functions for audio
  - Communication and Network Riser (CNR) interface

#### 1.8.2.2.1 IDE Interfaces

The ICH2's IDE controller has two independent bus-mastering IDE interfaces that can be independently enabled. The IDE interfaces support the following modes:

- Programmed I/O (PIO): CPU controls data transfer.
- 8237-style DMA: DMA offloads the CPU, supporting transfer rates of up to 16 MB/sec.
- Ultra DMA: DMA protocol on IDE bus supporting host and target throttling and transfer rates of up to 33 MB/sec.
- ATA-66: DMA protocol on IDE bus supporting host and target throttling and transfer rates of up to 66 MB/sec. ATA-66 protocol is similar to Ultra DMA and is device driver compatible.
- ATA-100: DMA protocol on IDE bus allows host and target throttling. The ICH2 ATA-100 logic can achieve read transfer rates up to 100 MB/sec and write transfer rates up to 88 MB/sec.

#### ⇒ NOTE

*ATA-66 and ATA-100 are faster timings and require a specialized cable to reduce reflections, noise, and inductive coupling.*



The IDE interfaces also support ATAPI devices (such as CD-ROM drives) and ATA devices using the transfer modes listed in Table 71 on page 121.

The BIOS supports Logical Block Addressing (LBA) and Extended Cylinder Head Sector (ECHS) translation modes. The drive reports the transfer rate and translation mode to the BIOS.

The D815EEA2 board supports Laser Servo (LS-120) diskette technology through its IDE interfaces. The LS-120 drive can be configured as a boot device by setting the BIOS Setup program's Boot menu to one of the following:

- ARMD-FDD (ATAPI removable media device – floppy disk drive)
- ARMD-HDD (ATAPI removable media device – hard disk drive)

For information about	Refer to
The location of the IDE connectors	Figure 15, page 73
The signal names of the IDE connectors	Table 43, page 77
BIOS Setup program's Boot menu	Section 4.7, page 130

### 1.8.2.2.2 USB

The ICH2 contains two separate USB controllers. The D815EPEA2 board has four USB ports; one USB peripheral can be connected to each port. For more than four USB devices, an external hub can be connected to any of the ports. The D815EPEA2 board fully supports the Universal Hub Controller Interface (UHCI).

In the standard configuration, the D815EPEA2 board's four USB ports are implemented with stacked back panel connectors, routed through the ICH2, as shown in Figure 8.

With the optional SMSC LPC47M142 I/O controller, the D815EPEA2 board supports up to seven USB ports. The SMSC LPC47M142 I/O controller provides four ports: two ports implemented with stacked back panel connectors and two ports routed to the optional front panel USB connector at location J8F1. The ICH2 provides three ports: two ports are implemented with stacked back panel connectors and the other port is accessible through a CNR add-in card, as shown in Figure 8.

The D815EPEA2 board fully supports the Universal Hub Controller Interface (UHCI).

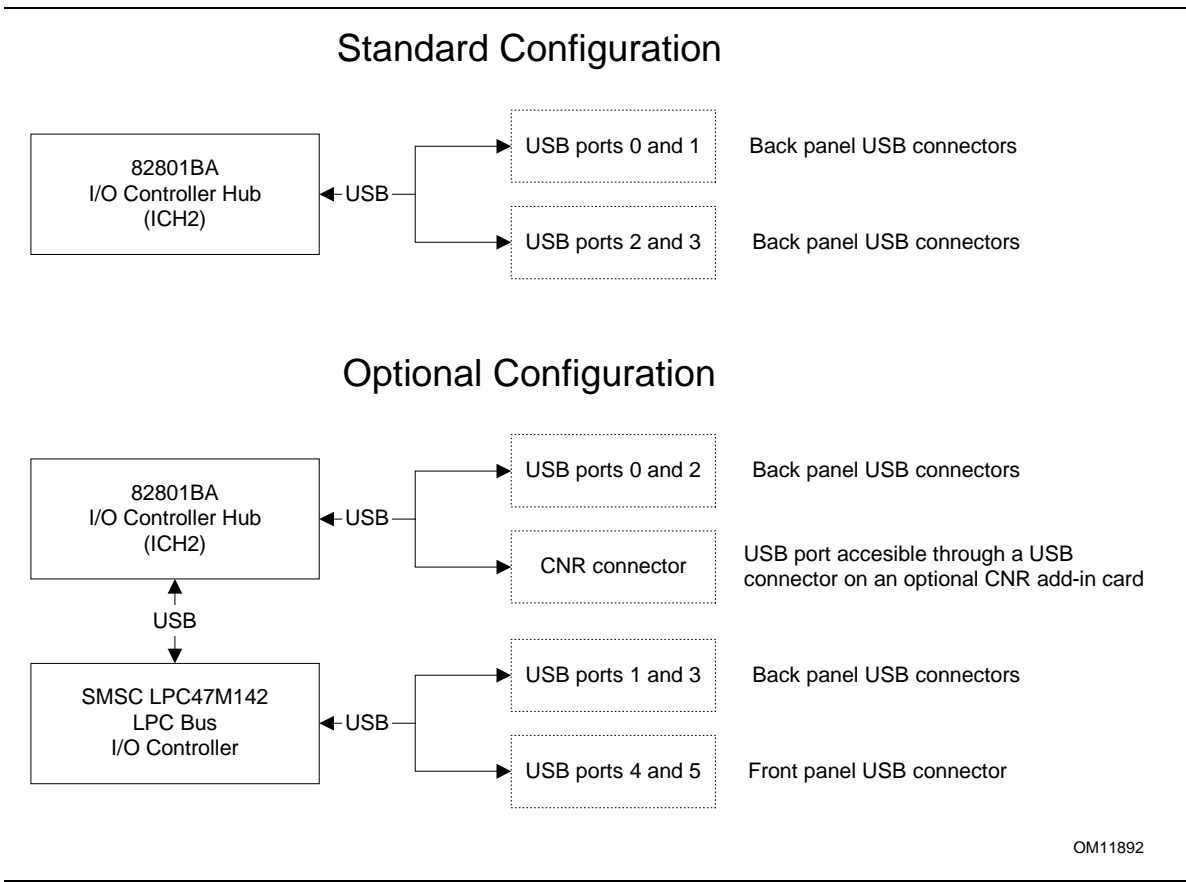

**Figure 8. USB Port Configurations**

⇒ **NOTE**

*Computer systems that have an unshielded cable attached to a USB port may not meet FCC Class B requirements, even if no device or a low-speed USB device is attached to the cable. Use shielded cable that meets the requirements for full-speed devices.*

For information about	Refer to
The location of the USB connectors on the back panel	Figure 13, page 64
The signal names of the back panel USB connectors	Table 21, page 65
The location of the optional front panel USB connector	Figure 16, page 78
The signal names of the optional front panel USB connector	Table 45, page 79
The USB specification and UHCI	Table 4, page 20

### 1.8.2.2.3 Real-Time Clock, CMOS SRAM, and Battery

The real-time clock provides a time-of-day clock and a multicentury calendar with alarm features. The real-time clock supports 256 bytes of battery-backed CMOS SRAM in two banks that are reserved for BIOS use.

A coin-cell battery (CR2032) powers the real-time clock and CMOS memory. When the computer is not plugged into a wall socket, the battery has an estimated life of three years. When the computer is plugged in, the standby current from the power supply extends the life of the battery. The clock is accurate to  $\pm 13$  minutes/year at 25 °C with 3.3 VSB applied.

The time, date, and CMOS values can be specified in the BIOS Setup program. The CMOS values can be returned to their defaults by using the BIOS Setup program.

#### ⇒ **NOTE**

*If the battery and AC power fail, custom defaults, if previously saved, will be loaded into CMOS SRAM at power-on.*

### 1.8.2.3 SST 49LF004A 4 Mbit Firmware Hub (FWH)

The system BIOS is stored in the FWH.

## 1.9 I/O Controller

The D815EEA2 and D815EPEA2 boards support either of two I/O controllers:

- The standard SMSC LPC47M132 I/O controller or
- The optional SMSC LPC47M142 I/O controller

Both I/O controllers provide the following features:

- Low pin count (LPC) interface
- 3.3 V operation
- Two serial ports
- One parallel port with Extended Capabilities Port (ECP) and Enhanced Parallel Port (EPP) support
- Serial IRQ interface compatible with serialized IRQ support for PCI systems
- PS/2-style mouse and keyboard interfaces
- Interface for one 1.2 MB, 1.44 MB, or 2.88 MB diskette drive
- Intelligent power management, including a programmable wake up event interface
- PCI power management support
- Fan control
  - One fan control output
  - Two fan tachometer inputs

The optional SMSC LPC47M142 I/O controller provides an additional USB hub.

The BIOS Setup program provides configuration options for the I/O controller.

For information about	Refer to
The USB hubs on the D815EEA2 board	Section 1.8.1.2.2, page 28
The USB hubs on the D815EPEA2 board	Section 1.8.2.2.2, page 33
SMSC LPC47M132 and LPC47M142 I/O controllers	<a href="http://www.smsc.com">http://www.smsc.com</a>

### 1.9.1 Serial Ports

The D815EEA2 and D815EPEA2 boards each have two serial ports. Serial port A is located on the back panel. Serial port B is accessible using the connector at location J8H1. The serial ports' NS16C550-compatible UARTs support data transfers at speeds up to 115.2 kbits/sec with BIOS support. The serial ports can be assigned as COM1 (3F8h), COM2 (2F8h), COM3 (3E8h), or COM4 (2E8h).

For information about	Refer to
The location of the serial port A connector	Figure 13, page 64
The signal names of the serial port A connector	Table 24, page 66
The location of the serial port B connector	Figure 16, page 78
The signal names of the serial port B connector	Table 44, page 79

## 1.9.2 Parallel Port

The connector for the parallel port is a 25-pin D-Sub connector located on the back panel. In the BIOS Setup program, the parallel port can be set to the following modes:

- Output only (PC-AT†-compatible mode)
- Bi-directional (PS/2 compatible)
- EPP
- ECP

For information about	Refer to
The location of the parallel port connector	Figure 13, page 64
The signal names of the parallel port connector	Table 23, page 65
Setting the parallel port's mode	Table 69, page 118

## 1.9.3 Diskette Drive Controller

The I/O controller supports one diskette drive that is compatible with the 82077 diskette drive controller and supports both PC-AT and PS/2 modes.

For information about	Refer to
The location of the diskette drive connector	Figure 15, page 73
The signal names of the diskette drive connector	Table 42, page 77
The supported diskette drive capacities and sizes	Table 72, page 123

## 1.9.4 Keyboard and Mouse Interface

PS/2 keyboard and mouse connectors are located on the back panel. The +5 V lines to these connectors are protected with a thermistor, which limits the current to a specified amperage.

### ⇒ NOTE

*The keyboard is supported in the bottom PS/2 connector and the mouse is supported in the top PS/2 connector. Power to the computer should be turned off before a keyboard or mouse is connected or disconnected.*

The keyboard controller contains the AMI keyboard and mouse controller code, provides the keyboard and mouse control functions, and supports password protection for power-on/reset. A power-on/reset password can be specified in the BIOS Setup program.

The keyboard controller also supports the hot-key sequence <Ctrl><Alt><Del> for a software reset (operating system dependent). This key sequence resets the computer's software by jumping to the beginning of the BIOS code and running the power-on self-test (POST).

For information about	Refer to
The location of the keyboard and mouse connectors	Figure 13, page 64
The signal names of the keyboard and mouse connectors	Table 20, page 65
Overcurrent protection for back panel connectors	Table 19, page 65

## 1.10 Graphics Subsystems

This section describes the graphics subsystems used by the D815EEA2 and D815EPEA2 boards:

- The D815EEA2 board uses the Intel 815E graphics subsystem, described below.
- The D815EPEA2 board uses the Intel 815EP graphics subsystem, described in Section 1.10.2, beginning on page 42.

### 1.10.1 Intel 815E Graphics Subsystem

The 815E chipset, used on the D815EEA2 board, contains two separate, mutually exclusive graphics options. Either the integrated graphics controller (contained within the 82815 GMCH) is used, or an add-in AGP adapter can be used.

The GMCH includes an integrated display cache SDRAM controller that supports a Graphics Performance Accelerator (GPA) card. The GPA card is a 32-bit 133 MHz 4 MB SDRAM array for enhanced integrated 2D and 3D graphics performance. This interface is multiplexed between the display cache interface and the AGP connector. When an AGP card is installed, the integrated graphics controller is disabled and the display cache interface is not used.

For information about	Refer to
GPA support	Section 1.10.1.3.1, page 41

#### 1.10.1.1 Integrated Graphics Controller

The GMCH features the following:

- Integrated graphics controller
  - 3-D Hyperpipelined architecture
  - Full 2-D hardware acceleration
  - Motion video acceleration
- 3-D graphics visual and texturing enhancement
- Display
  - Integrated 24-bit 230 MHz RAMDAC
  - Display Data Channel Standard, Version 3.0, Level 2B protocols compliant
- Video
  - Hardware motion compensation for software MPEG2 decode
  - Software DVD at 30 fps
- Integrated graphics memory controller

Table 7 lists the refresh frequencies supported by the graphics subsystem.

**Table 7. Supported Graphics Refresh Frequencies**

Resolution	Color Palette	Available Refresh Frequencies (Hz)	Notes
320 x 200	256 colors	70	D
	64 K colors	70	D3
	16 M colors	70	D
320 x 240	256 colors	70	D
	64 K colors	70	D3
	16 M colors	70	D
352 x 480	256 colors	70	D
	64 K colors	70	D3
	16 M colors	70	D
352 x 576	256 colors	70	D
	64 K colors	70	D3
	16 M colors	70	D
400 x 300	256 colors	70	D
	64 K colors	70	D3
	16 M colors	70	D
512 x 384	256 colors	70	D
	64 K colors	70	D3
	16 M colors	70	D
640 x 400	256 colors	70	D
	64 K colors	70	D3
	16 M colors	70	D
640 x 480	256 colors	60, 70, 72, 75, 85	KDO
	64 K colors	60, 75, 85	KD30
	64 K colors	70, 72	KDO
640 x 480	16 M colors	60, 70, 72, 75, 85	KDO
800 x 600	256 colors	60, 70, 72, 75, 85	KDO
	64 K colors	60, 70, 72, 75, 85	KD30
	16 M colors	60, 70, 72, 75, 85	KDO
1024 x 768	256 colors	60, 70, 75, 85	KDO
	64 K colors	60, 70, 75	KD30
	64 K colors	85	KD3
	16 M colors	60, 70, 75, 85	KD

continued

**Table 7. Supported Graphics Refresh Frequencies (continued)**

Resolution	Color Palette	Available Refresh Frequencies (Hz)	Notes
1152 x 864	256 colors	60, 70, 72, 75	KDO
	256 colors	85	KD
	64 K colors	60, 70	KD3O
	64 K colors	72, 75, 85	KD3
	16 M colors	60	KDO
	16 M colors	75, 85	KD
1280 x 768	256 colors	60 (reduced blanking)	KDOF
	64 K colors	60 (reduced blanking)	KD3F
	16 M colors	60 (reduced blanking)	KDF
1280 x 1024	256 colors	60	KDO
	256 colors	70, 72, 75, 85	KD
	64 K colors	60, 70, 72, 75, 85	KD3
	16 M colors	60, 70, 75, 85	KD
1600 x 1200	256 colors	60, 70, 72, 75	KD

Notes: K = Desktop  
D = DirectDraw†  
3 = Direct3D† and OpenGL†  
O = Overlay  
F = Digital Display Device only. A mode will be supported on both analog CRTs and digital display devices (KD3O applies to both types of displays), unless indicated otherwise.

For information about	Refer to
Obtaining graphics software and utilities	Section 1.3, page 19

### 1.10.1.2 Digital Video Output (DVO) Connector (Optional)

The D815EEA2 board routes the Intel 82815 GMCH DVO port to an optional onboard 40-pin DVO connector. The DVO connector can be cabled to a DVI or TV out card to enable digital displays or TV out functionality. The Digital Visual Interface (DVI) specification provides a high-speed digital connection for visual data types when using the integrated graphics controller. This interface is active only when the integrated graphics controller is enabled.

The DVI interface allows interfacing with a discrete Transmission Minimized Differential Signaling (TMDS) transmitter to enable platform support for DVI compliant digital displays or with a discrete TV encoder for TV out functionality.

For information about	Refer to
The location of the DVO connector	Figure 14, page 69
The signal names of the DVO connector	Table 32, page 71
Obtaining the DVI specification	Table 4, page 20



### 1.10.1.3 AGP Universal Connector

#### ⇒ NOTE

*Install memory in the DIMM sockets prior to installing the AGP video card to avoid interference with the memory retention mechanism.*

The AGP universal connector supports either:

- Graphics Performance Accelerator (GPA) cards with 133 MHz SDRAM display cache
- 1x, 2x, or 4x AGP add-in cards with either 3.3 V or 1.5 V I/O

For information about	Refer to
The location of the AGP universal connector	Figure 15, page 73
The signal names of the AGP universal connector	Table 41, page 76

#### 1.10.1.3.1 Graphics Performance Accelerator (GPA) Support

The Intel 815E GMCH display cache is a single channel 32-bit wide SDRAM interface. The 4 MB display cache resides on a GPA card that plugs into the AGP connector. The BIOS detects a GPA card if present in the AGP port and initializes it as display cache memory. When a GPA card is initialized, the BIOS allocates 1 MB of system memory to support the internal display device operation.

#### 1.10.1.3.2 Dynamic Video Memory Technology (DVMT)

DVMT enables enhanced graphics and memory performance through Direct AGP, and highly efficient memory utilization. DVMT ensures the most efficient use of all available memory for maximum 2D/3D graphic performance. DVMT is implemented on the D815EEA2 board with a GPA (Graphics Performance Accelerator) card installed in the AGP connector.

#### ⇒ NOTE

*In earlier documentation, the GPA card was referred to as the AGP Inline Memory Module (AIMM).*

DVMT uses 1 MB of system physical memory for compatibility with legacy applications. An example of this would be when using VGA graphics under DOS. Once loaded, the operating system and graphics drivers allocate the buffers needed for performing graphics functions. When the 4 MB GPA card is installed, the Z-buffer and GDI data are managed directly from this dedicated graphics memory thereby avoiding operating system memory manager calls and improving performance.

At system BIOS POST, the BIOS displays either the amount of physical memory allocated for display cache or the size of the GPA card (4 MB) if installed. Operating systems such as Windows NT 4.0 and Windows 2000 may display the maximum amount of frame buffer memory possible based on the system memory configuration.

## ⇒ NOTE

*The use of DVMT requires operating system driver support.*

For information about	Refer to
Obtaining the DVMT white paper	<a href="http://developer.intel.com/design/chipsets/815e/">http://developer.intel.com/design/chipsets/815e/</a>
Obtaining the AIMM specification	Table 4, page 20

### 1.10.1.3.3 AGP Add-in Card Support

AGP is a high-performance interface for graphics-intensive applications, such as 3D applications. While based on the *PCI Local Bus Specification*, Rev. 2.1, AGP is independent of the PCI bus and is intended for exclusive use with graphical display devices. AGP overcomes certain limitations of the PCI bus related to handling large amounts of graphics data with the following features:

- Pipelined memory read and write operations that hide memory access latency
- Demultiplexing of address and data on the bus for nearly 100 percent efficiency

For information about	Refer to
Obtaining the <i>Accelerated Graphics Port Interface Specification</i>	Table 4, page 20

## 1.10.2 Intel 815EP Graphics Subsystem

### ⇒ NOTE

*Install memory in the DIMM sockets prior to installing the AGP video card to avoid interference with the memory retention mechanism.*

The Intel 815EP chipset, used on the D815EPEA2 board, provides an AGP universal connector which supports a 1x, 2x, or 4x AGP add-in card with either 3.3 V or 1.5 V I/O.

AGP is a high-performance interface for graphics-intensive applications, such as 3D applications. While based on the *PCI Local Bus Specification*, Rev. 2.1, AGP is independent of the PCI bus and is intended for exclusive use with graphical display devices. AGP overcomes certain limitations of the PCI bus related to handling large amounts of graphics data with the following features:

- Pipelined memory read and write operations that hide memory access latency
- Demultiplexing of address and data on the bus for nearly 100 percent efficiency

For information about	Refer to
The location of the AGP universal connector	Figure 15, page 73
The signal names of the AGP universal connector	Table 41, page 76
Obtaining the <i>Accelerated Graphics Port Interface Specification</i>	Table 4, page 20

## 1.11 Audio Subsystem

The D815EEA2 and D815EPEA2 boards both include an Audio Codec '97 (AC '97) compatible audio subsystem consisting of these devices:

- Intel 82801BA I/O Controller Hub (ICH2)
- Analog Devices AD1885 analog codec

### 1.11.1 AD1885 Audio Codec

The AD1885 is a fully AC '97 compliant codec. The codec's features include:

- > 90 dB signal-to-noise ratio sound quality
- Power management support for APM 1.2 and ACPI 1.0 (driver dependant)
- Playback sample rates up to 48 kHz
- 16 bit stereo full-duplex codec
- Software compatible with Windows 98 SE, Windows 2000, Windows NT 4.0, and Windows Millennium (Me)
- Full-duplex operation at asynchronous hardware record/playback samples rates
- Frequency response: 20 Hz to 20 kHz ( $\pm 0.1$  dB)

Figure 9 is a block diagram of the D815EEA2 and D815EPEA2 boards' audio subsystem, including the Intel 82801BA ICH2 digital controller, the AD1885 analog codec, and the audio connectors.

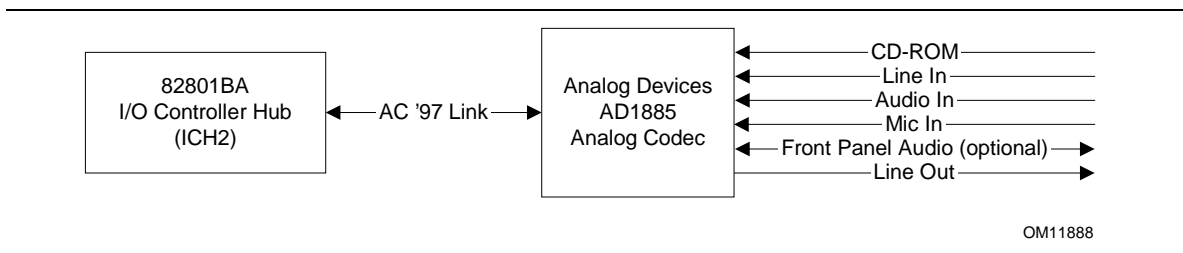

**Figure 9. Block Diagram of Audio Subsystem**

For information about	Refer to
Obtaining the AC '97 specification	Table 4, page 19

### 1.11.2 Audio Connectors

The audio connectors include the following:

- Front panel audio (optional):
  - Mic in
  - Line out
- ATAPI-style connectors:
  - CD-ROM
  - Auxiliary line in

- Back panel audio connectors:
  - Line in
  - Line out
  - Mic in

For information about	Refer to
The back panel audio connectors	Section 2.8.1, page 64

### 1.11.2.1 Front Panel Audio Connector (Optional)

A 2 x 5-pin connector for routing mic in and line out to the front panel.

For information about	Refer to
The location of the optional front panel audio connector	Figure 14, page 69
The signal names of the optional front panel audio connector	Table 30, page 70

#### ⇒ NOTE

*The front panel audio connector is alternately used as a jumper block for routing audio signals. Refer to Section 2.9.1 on page 82 for more information.*

### 1.11.2.2 ATAPI CD-ROM Connector

A 1 x 4-pin ATAPI-style connector connects an internal ATAPI CD-ROM drive to the audio mixer.

For information about	Refer to
The location of the ATAPI CD-ROM connector	Figure 14, page 69
The signal names of the ATAPI CD-ROM connector	Table 31, page 70

### 1.11.2.3 Auxiliary Line In Connector

A 1 x 4-pin ATAPI-style connector connects the left and right channel signals of an internal audio device to the audio subsystem.

For information about	Refer to
The location of the auxiliary line in connector	Figure 14, page 69
The signal names of the auxiliary line in connector	Table 29, page 70

## 1.12 LAN Subsystem (Optional)

The network interface controller subsystem consists of the ICH2, with integrated LAN Media Access Controller (MAC), and a physical layer interface device. Features of the LAN subsystem include:

- PCI Bus Master Interface
- CSMA/CD Protocol Engine
- Serial CSMA/CD unit interface that supports the following physical layer interface devices:
  - 82562ET onboard LAN
  - 82562ET/MT (10/100 Mbit/sec Ethernet) on the optional CNR
  - 82562EH (1 Mbit/sec HomePNA<sup>†</sup>) on the optional CNR
- PCI Power Management
  - Supports APM
  - Supports ACPI technology
  - Supports Wake up from suspend state (optional Wake on LAN technology)

### For information about

### Refer to

Obtaining LAN software and drivers

Section 1.3, page 19

### 1.12.1 Intel® 82562ET Platform LAN Connect Device

The Intel 82562ET component provides an interface to the back panel RJ-45 connector with integrated LEDs. This physical interface may alternately be provided through the CNR connector.

The Intel 82562ET provides the following functions:

- Basic 10/100 Ethernet LAN Connectivity
- Supports RJ-45 connector with status indicator LEDs
- Full driver compatibility
- Advanced Power Management support
- Programmable transit threshold
- Configuration EEPROM that contains the MAC address

### 1.12.2 RJ-45 LAN Connector LEDs

Two LEDs are built into the RJ-45 LAN connector. Table 8 describes the LED states when the board is powered up and the LAN subsystem is operating.

**Table 8. LAN Connector LED States**

LED Color	LED State	Condition
Green	Off	10 Mbit/sec data rate is selected.
	On	100 Mbit/sec data rate is selected.
Yellow	Off	LAN link is not established.
	On (steady state)	LAN link is established.
	On (brighter and pulsing)	The computer is communicating with another computer on the LAN.

## 1.13 Hardware Management Subsystem

The hardware management features enable the board to be compatible with the Wired for Management (WfM) specification. The board has several hardware management features, including the following:

- Hardware monitoring
- Chassis intrusion detect connector (optional)
- Fan control and monitoring (implemented on both the SMSC LPC47M132 and optional SMSC LPC47M142 I/O controllers)

For information about	Refer to
The WfM specification	Table 4, page 19
Fan control functions of the SMSC LPC47M132 and optional SMSC LPC47M142 I/O controllers	Section 1.13.2, page 46

### 1.13.1 Hardware Monitor Component

The hardware monitor component provides low-cost instrumentation capabilities. The features of the component include:

- Internal ambient temperature sensing
- Remote thermal diode sensing for direct monitoring of processor temperature (if supported in the processor)
- Power supply monitoring (+12 V, +5 V, +3.3 V, +2.5 V, 3.3 VSB, and VCCP) to detect levels above or below acceptable values
- SMBus interface

### 1.13.2 Chassis Intrusion Detect Connector (Optional)

The board supports a chassis security feature that detects if the chassis cover is removed. For the chassis intrusion circuit to function, the chassis' power supply must be connected to AC power. The security feature uses a mechanical switch on the chassis that attaches to the chassis intrusion detect connector. The mechanical switch is closed for normal computer operation. Chassis intrusion detection can be supported with third party SMBus software.

For information about	Refer to
The location of the optional chassis intrusion detect connector	Figure 14, page 69
The signal names of the optional chassis intrusion detect connector	Table 37, page 72

### 1.13.3 Fan Control and Monitoring

The SMSC LPC47M132 I/O controller and the optional SMSC LPC47M142 I/O controller both provide fan tachometer input for the processor fan (fan 1) and system fan (fan 2) and fan control output for the system fan (fan 2) and the chassis fan (fan 3). Monitoring and control can be implemented using third-party software.

For information about	Refer to
The functions of the fan connectors	Section 1.15.2.2, page 53
The location of the fan connectors	Figure 14, page 69
The signal names of the fan connectors	Section 2.8.2.2, page 69

## 1.14 CNR Connector (Optional)

The CNR connector supports the audio, modem, USB, and LAN interfaces of the Intel 815E and Intel 815EP chipsets. Figure 10 shows the signal interface between the riser and the ICH2.

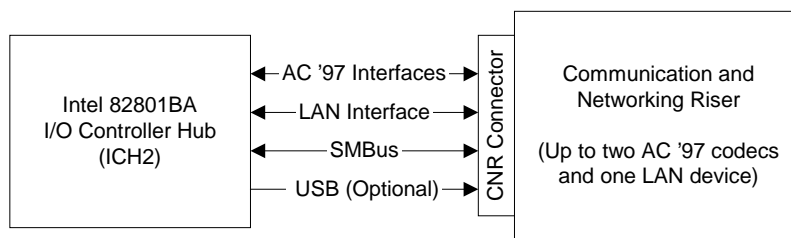

OM11484

**Figure 10. ICH2 and CNR Signal Interface**

#### ⇒ NOTE

*The USB interface from the ICH2 to the CNR is optional on this board.*

The interfaces supported by the CNR connector include (but are not limited to) the following:

- **AC '97 interface:** supports audio and/or modem functions on the CNR board.
- **LAN interface:** interface includes an eight-pin interface for use with Platform LAN Connect (PLC) based devices.
- **SMBus interface:** provides Plug-and-Play functionality for the CNR board.
- **USB interface (optional):** provides a USB interface for the CNR board.

To learn more about the CNR, refer to the CNR specification.

For information about	Refer to
Obtaining the CNR specification	Table 4, page 20

## 1.15 Power Management

Power management is implemented at several levels, including:

- Software support:
  - Advanced Power Management (APM)
  - Advanced Configuration and Power Interface (ACPI)
- Hardware support:
  - Power connector
  - Fan connectors
  - Wake on LAN technology
  - Instantly Available technology
  - Resume on Ring
  - Wake from USB
  - Wake on Keyboard
  - Wake on PME#
  - Wake on RTC (real-time clock) alarm

### 1.15.1 Software Support

The software support for power management includes:

- APM
- ACPI

If the D815EEA2 or D815EPEA2 board is used with an ACPI-aware operating system, the BIOS can provide ACPI support. Otherwise, it defaults to APM support.

#### 1.15.1.1 APM

APM makes it possible for the computer to enter an energy-saving standby mode. The standby mode can be initiated in the following ways:

- Time-out period specified in the BIOS Setup program
- From the operating system, such as the standby menu item in Windows 98

In standby mode, the D815EEA2 and D815EPEA2 boards can reduce power consumption by spinning down hard drives, and reducing power to, or turning off of, VESA<sup>†</sup> DPMS-compliant monitors. Power management mode can be enabled or disabled in the BIOS Setup program.

While in standby mode, the system retains the ability to respond to external interrupts and service requests, such as incoming faxes or network messages. Any keyboard or mouse activity brings the system out of standby mode and immediately restores power to the monitor.



The BIOS enables APM by default; but the operating system must support an APM driver for the power management features to work. For example, Windows 98 supports the power management features upon detecting that APM is enabled in the BIOS.

For information about	Refer to
Enabling or disabling power management in the BIOS Setup program	Section 4.6, page 127
The D815EEA2 and D815EPEA2 boards' compliance level with APM	Table 4, page 20

### 1.15.1.2 ACPI

ACPI gives the operating system direct control over the power management and Plug and Play functions of a computer. The use of ACPI with the D815EEA2 or D815EPEA2 board requires an operating system that provides full ACPI support. ACPI features include:

- Plug and Play (including bus and device enumeration) and APM support normally contained in the BIOS
- Power management control of individual devices, add-in boards (some add-in boards may require an ACPI-aware driver), video displays, and hard disk drives
- Methods for achieving less than 15-watt system operation in the power-on/standby sleeping state
- A soft-off feature that enables the operating system to power-off the computer
- Support for multiple wake up events (see Table 11 on page 51)
- Support for a front panel power and sleep mode switch. Table 9 lists the system states based on how long the power switch is pressed, depending on how ACPI is configured with an ACPI-aware operating system.

**Table 9. Effects of Pressing the Power Switch**

If the system is in this state...	...and the power switch is pressed for	...the system enters this state
Off (ACPI G2/G5 – soft-off)	Less than seven seconds	Power-on (ACPI G0 – working state)
On (ACPI G0 – working state)	Less than seven seconds	Soft-off/Standby (ACPI G1 – sleeping state)
On (ACPI G0 – working state)	More than seven seconds	Fail safe power-off (ACPI G2/G5 – soft-off)
Sleep (ACPI G1 – sleeping state)	Less than seven seconds	Wake up (ACPI G0 – working state)
Sleep (ACPI G1 – sleeping state)	More than seven seconds	Power-off (ACPI G2/G5 – soft-off)

For information about	Refer to
The D815EEA2 and D815EPEA2 boards' compliance level with ACPI	Table 4, page 20

### 1.15.1.2.1 System States and Power States

Under ACPI, the operating system directs all system and device power state transitions. The operating system puts devices in and out of low-power states based on user preferences and knowledge of how devices are being used by applications. Devices that are not being used can be turned off. The operating system uses information from applications and user settings to put the system as a whole into a low-power state.

Table 10 lists the power states supported by the D815EEA2 and D815EPEA2 boards along with the associated system power targets. See the ACPI specification for a complete description of the various system and power states.

**Table 10. Power States and Targeted System Power**

Global States	Sleeping States	CPU States	Device States	Targeted System Power (Note 1)
G0 – working state	S0 – working	C0 – working	D0 – working state	Full power > 30 W
G1 – sleeping state	S1 – CPU stopped	C1 – stop grant	D1, D2, D3 – device specification specific.	5 W < power < 30 W
G1 – sleeping state	S3 – suspend to RAM. Context saved to RAM.	No power	D3 – no power except for wake up logic.	Power < 5 W (Note 2)
G2/S5	S5 – soft-off. Context not saved. Cold boot is required.	No power	D3 – no power except for wake up logic.	Power < 5 W (Note 2)
G3 – mechanical off AC power is disconnected from the computer.	No power to the system.	No power	D3 – no power for wake up logic, except when provided by battery or external source.	No power to the system so that service can be performed.

Notes:

1. Total system power is dependent on the system configuration, including add-in boards and peripherals powered by the system chassis' power supply.
2. Dependent on the standby power consumption of wake-up devices used in the system.

### 1.15.1.2.2 Wake Up Devices and Events

Table 11 lists the devices or specific events that can wake the computer from specific states.

**Table 11. Wake Up Devices and Events**

These devices/events can wake up the computer...	...from this state
Power switch	S1, S3, S5
RTC alarm	S1, S3, S5 (Note 1)
Wake on LAN technology connector (optional)	S1, S3, S5 (Notes 1 and 2)
PME#	S1, S3, S5 (Notes 1 and 2)
Modem (back panel serial port A)	S1, S3 (Note 3)
USB	S1, S3
PS/2 keyboard	S1, S3

Notes:

1. S5 events are supported only on PCI bus connector 2.
2. For the Wake on LAN technology connector and PME#, S5 is disabled by default in the BIOS Setup program. Setting these options to Power On will enable a wake-up event from LAN in the S5 state.
3. Wake from CNR modem is not supported on the D815EEA2 and D815EPEA2 boards.

#### ⇒ NOTE

*The use of these wake up events from an ACPI state requires an operating system that provides full ACPI support. In addition, software, drivers, and peripherals must fully support ACPI wake events.*

#### ⇒ NOTE

*Wake up from PS/2 mouse is peripheral, operating system, and driver dependent; it is not a board-level feature.*

### 1.15.1.2.3 Plug and Play

In addition to power management, ACPI provides controls and information so that the operating system can facilitate Plug and Play device enumeration and configuration. ACPI is used only to enumerate and configure D815EEA2 and D815EPEA2 board devices that do not have other hardware standards for enumeration and configuration. PCI devices on the D815EEA2 and D815EPEA2 boards, for example, are not enumerated by ACPI.

## 1.15.2 Hardware Support



### CAUTION

*If the Wake on LAN and Instantly Available technology features are used, ensure that the power supply provides adequate +5 V standby current. Failure to do so can damage the power supply. The total amount of standby current required depends on the wake devices supported and manufacturing options. Refer to Section 2.11.3 on page 94 for additional information.*

The boards provides several hardware features that support power management, including:

- Power connector
- Fan connectors
- Wake on LAN technology connector (optional)
- Instantly Available technology
- Resume on Ring
- Wake from USB
- Wake from PS/2 keyboard
- PME# wakeup support

Wake on LAN technology and Instantly Available technology require power from the +5 V standby line. The sections discussing these features describe the incremental standby power requirements for each.

Resume on Ring enables telephony devices to access the computer when it is in a power-managed state. The method used depends on the type of telephony device (external or internal) and the power management mode being used (APM or ACPI).

### ⇒ NOTE

*The use of Resume on Ring and Wake from USB technologies from an ACPI state requires an operating system that provides full ACPI support.*

### 1.15.2.1 Power Connector

When used with an ATX-compliant power supply that supports remote power on/off, the D815EEA2 and D815EPEA2 boards can turn off the system power through software control. To enable soft-off control in software, advanced power management must be enabled in the BIOS Setup program and in the operating system. When the system BIOS receives the correct APM command from the operating system, the BIOS turns off power to the computer.

With soft-off enabled, if power to the computer is interrupted by a power outage or a disconnected power cord, when power resumes, the computer returns to the power state it was in before power was interrupted (on or off). The computer's response can be set using the After Power Failure feature in the BIOS Setup program's Power menu.

For information about	Refer to
The location of the power connector	Figure 14, page 69
The signal names of the power connector	Table 34, page 71
The BIOS Setup program's Power menu	Section 4.6, page 127
The ATX specification	Table 3, page 19

### 1.15.2.2 Fan Connectors

The D815EEA2 and D815EPEA2 boards both have two standard fan connectors and one optional fan connector. The functions of these connectors are described in Table 12.

**Table 12. Fan Connector Descriptions**

Connector	Silkscreen Label	Reference Designator	Function
Processor fan	Fan 1	J1B1	Provides +12 V DC for a processor fan or active fan heatsink. A tachometer feedback connection is also provided.
System fan	Fan 2	J9H1	Provides +12 V DC for a system or chassis fan. The fan voltage can be switched on or off, depending on the power management state of the computer. A tachometer feedback connection is also provided.
Chassis fan (optional)	Fan 3	J4G1	Provides +12 V DC for a system or chassis. The fan voltage can be switched on or off, depending on the power management state of the computer.

For information about	Refer to
The location of the fan connectors	Figure 14, page 69
The signal names of the fan connectors	Section 2.8.2.2, page 69

### 1.15.2.3 Wake on LAN Technology



#### CAUTION

*For Wake on LAN technology, the +5 V standby line for the power supply must be capable of providing adequate +5 V standby current. Failure to provide adequate standby current when implementing Wake on LAN technology can damage the power supply. Refer to Section 2.11.3 on page 94 for additional information.*



#### NOTE

*The optional Wake on LAN technology connector is present only on boards that do not have the Intel 82562ET PLC device, which is part of the optional onboard LAN subsystem.*

Wake on LAN technology enables remote wakeup of the computer through a network. The LAN subsystem PCI bus network adapter monitors network traffic at the Media Independent Interface. Upon detecting a Magic Packet<sup>†</sup> frame, the LAN subsystem asserts a wakeup signal that powers up the computer. Depending on the LAN implementation, the D815EEA2 and D815EPEA2 boards support Wake on LAN technology in the following ways:

- Through the optional Wake on LAN technology connector (APM only)
- Through the PCI bus PME# signal for PCI 2.2 compliant LAN designs (ACPI only)
- Through the onboard LAN subsystem when enabled in Setup (ACPI only)

The Wake on LAN technology connector can be used with PCI bus network adapters that have a remote wake up connector, as shown in Figure 11. Network adapters that are PCI 2.2 compliant assert the wakeup signal through the PCI bus signal PME# (pin A19 on the PCI bus connectors).

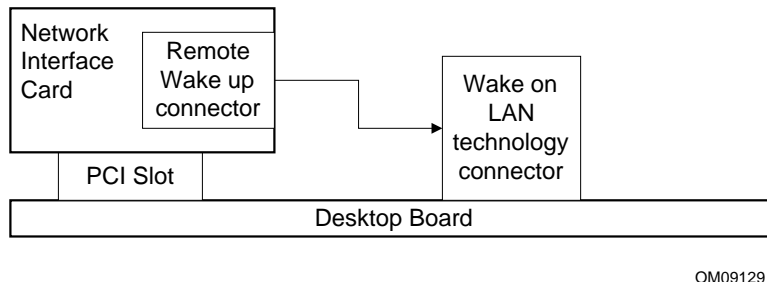

Figure 11. Using the Wake on LAN Technology Connector

For information about	Refer to
The location of the optional Wake on LAN technology connector	Figure 14, page 69
The signal names of the optional Wake on LAN technology connector	Table 38, page 72

### 1.15.2.4 Instantly Available Technology



#### CAUTION

*For Instantly Available technology, the 5 V standby line for the power supply must be capable of providing adequate +5 V standby current. Failure to provide adequate standby current when implementing Instantly Available technology can damage the power supply. Refer to Section 2.11.3 on page 94 for additional information.*

Instantly Available technology enables the D815EEA2 and D815EPEA2 boards to enter the ACPI S3 (suspend-to-RAM) sleep-state. While in the S3 sleep-state, the computer will appear to be off (the power supply is off, the fans are off, and the front panel LED is amber if dual-color, or off if single-color.) When signaled by a wake-up device or event, the system quickly returns to its last known wake state.

The D815EEA2 and D815EPEA2 boards support the *PCI Bus Power Management Interface Specification*. Add-in boards that also support this specification can participate in power management and can be used to wake the computer.

The use of Instantly Available technology requires operating system support and PCI 2.2 compliant add-in cards and drivers.

The standby power indicator LED (at location CR6E1) shows that power is still present at the DIMM and PCI bus connectors, even when the computer appears to be off. Figure 12 shows the location of the standby power indicator LED on the D815EEA2 and D815EPEA2 boards.

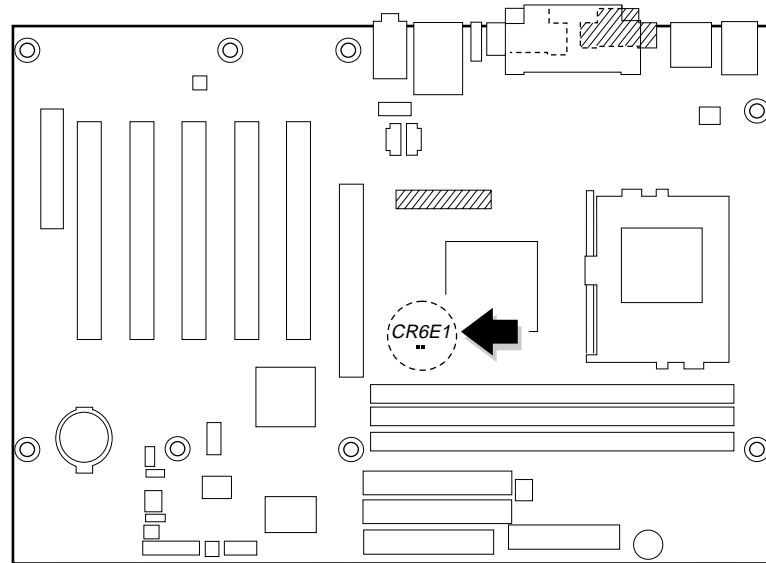

 Present only on D815EEA2 boards

OM11462

**Figure 12. Location of Standby Power Indicator LED**

**For information about**

The devices and events that can wake the computer from the S3 state

The *PCI Bus Power Management Interface Specification*

**Refer to**

Table 11, page 51

Table 4, page 20

#### 1.15.2.5 Resume on Ring

The operation of Resume on Ring can be summarized as follows:

- Resumes operation from either the APM sleep mode or the ACPI S1 state
- Requires only one call to access the computer
- Detects incoming call similarly for external and internal modems
- Requires modem interrupt be unmasked for correct operation

#### 1.15.2.6 Wake from USB

USB bus activity wakes the computer from an ACPI S1 or S3 state.

#### ⇒ NOTE

*Wake from USB requires the use of a USB peripheral that supports Wake from USB.*

#### 1.15.2.7 Wake from PS/2 Keyboard

PS/2 keyboard activity wakes the computer from an ACPI S1 or S3 state.

#### 1.15.2.8 PME# Wakeup Support

When the PME# signal on the PCI bus is asserted, the computer wakes from an ACPI S1, S3, or S5 state.

#### 1.15.2.9 Wake from RTC Alarm

An RTC alarm wakes the computer from an ACPI S1, S3, or S5 state.



## 2 Technical Reference

---

### What This Chapter Contains

2.1	Introduction.....	57
2.2	Memory Map .....	57
2.3	I/O Map.....	58
2.4	DMA Channels .....	60
2.5	PCI Configuration Space Map .....	60
2.6	Interrupts .....	61
2.7	PCI Interrupt Routing Map .....	61
2.8	Connectors .....	63
2.9	Jumper Blocks .....	82
2.10	Mechanical Considerations.....	84
2.11	Electrical Considerations .....	92
2.12	Thermal Considerations.....	96
2.13	Reliability .....	97
2.14	Environmental.....	98
2.15	Regulatory Compliance .....	99

### 2.1 Introduction

Sections 2.2 - 2.6 contain several standalone tables. Table 13 describes the system memory map, Table 14 shows the I/O map, Table 15 lists the DMA channels, Table 16 defines the PCI configuration space map, and Table 17 describes the interrupts. The remaining sections in this chapter are introduced by text found with their respective section headings.

### 2.2 Memory Map

**Table 13. System Memory Map**

Address Range (decimal)	Address Range (hex)	Size	Description
1024 K - 524288 K	100000 - 1FFFFFFF	511 MB	Extended memory
960 K - 1024 K	F0000 - FFFFF	64 KB	Runtime BIOS
896 K - 960 K	E0000 - EFFFF	64 KB	Reserved
800 K - 896 K	C8000 - DFFFF	96 KB	Available high DOS memory (open to the PCI bus)
640 K - 800 K	A0000 - C7FFF	160 KB	Video memory and BIOS
639 K - 640 K	9FC00 - 9FFFF	1 KB	Extended BIOS data (movable by memory manager software)
512 K - 639 K	80000 - 9FBFF	127 KB	Extended conventional memory
0 K - 512 K	00000 - 7FFFF	512 K	Conventional memory

## 2.3 I/O Map

**Table 14. I/O Map**

Address (hex)	Size	Description
0000 - 000F	16 bytes	DMA controller
0020 - 0021	2 bytes	Programmable Interrupt Control (PIC)
0040 - 0043	4 bytes	System timer
0060	1 byte	Keyboard controller byte—reset IRQ
0061	1 byte	System speaker
0064	1 byte	Keyboard controller, CMD/STAT byte
0070 - 0071	2 bytes	System CMOS/Real Time Clock
0072 - 0073	2 bytes	System CMOS
0080 - 008F	16 bytes	DMA controller
0092	1 byte	Fast A20 and PIC
00A0 - 00A1	2 bytes	PIC
00B2 - 00B3	2 bytes	APM control
00C0 - 00DF	32 bytes	DMA
00F0	1 byte	Numeric data processor
0170 - 0177	8 bytes	Secondary IDE channel
01F0 - 01F7	8 bytes	Primary IDE channel
One of these ranges: 0200 - 0207 0208 - 020F 0210 - 0217 0218 - 021F	Can vary from 1 byte to 8 bytes	Audio
One of these ranges: 0220 - 022F 0240 - 024F	16 bytes	Audio (Sound Blaster Pro-compatible)
0228 - 022F*	8 bytes	LPT3
0278 - 027F*	8 bytes	LPT2
02E8 - 02EF*	8 bytes	COM4/video (8514A)
02F8 - 02FF*	8 bytes	COM2
0376	1 byte	Secondary IDE channel command port
0377, bits 6:0	7 bits	Secondary IDE channel status port
0378 - 037F	8 bytes	LPT1
03B0 - 03BB	12 bytes	Intel 82815 GMCH/AGP
03C0 - 03DF	32 bytes	Intel 82815 GMCH/AGP
03E8 - 03EF	8 bytes	COM3
03F0 - 03F5	6 bytes	Diskette channel 1
03F6	1 byte	Primary IDE channel command port
03F8 - 03FF	8 bytes	COM1
04D0 - 04D1	2 bytes	Edge/level triggered PIC
LPTn + 400	8 bytes	ECP port, LPTn base address + 400h
0CF8 - 0CFB**	4 bytes	PCI configuration address register
0CF9***	1 byte	Turbo and reset control register
0CFC - 0CFF	4 bytes	PCI configuration data register

continued

**Table 14. I/O Map (continued)**

Address (hex)	Size	Description
FFA0 - FFA7	8 bytes	Primary bus master IDE registers
FFA8 - FFAF	8 bytes	Secondary bus master IDE registers
96 contiguous bytes starting on a 128-byte divisible boundary		ICH2 (ACPI + TCO)
64 contiguous bytes starting on a 64-byte divisible boundary		D815EEA2/D815EPEA2 board resource
64 contiguous bytes starting on a 64-byte divisible boundary		ICH2 LAN controller
64 contiguous bytes starting on a 64-byte divisible boundary		ICH2 AC '97 audio master
256 contiguous bytes starting on a 256-byte divisible boundary		ICH2 AC '97 audio mixer
256 contiguous bytes starting on a 256-byte divisible boundary		ICH2 AC '97 modem mixer
32 contiguous bytes starting on a 32-byte divisible boundary		ICH2 USB controller #1
32 contiguous bytes starting on a 32-byte divisible boundary		ICH2 USB controller #2
16 contiguous bytes starting on a 16-byte divisible boundary		ICH2 (SMBus)
4096 contiguous bytes starting on a 4096-byte divisible boundary		Intel 82801BA PCI bridge

\* Default, but can be changed to another address range.

\*\* Dword access only

\*\*\* Byte access only

⇒ **NOTE**

*Some additional I/O addresses are not available due to ICH2 addresses aliasing.*

For information about	Refer to
ICH2 addressing	Section 1.3, page 19

## 2.4 DMA Channels

**Table 15. DMA Channels**

DMA Channel Number	Data Width	System Resource
0	8 or 16 bits	Audio
1	8 or 16 bits	Audio/parallel port
2	8 or 16 bits	Diskette drive
3	8 or 16 bits	Parallel port (for ECP or EPP)/audio
4	8 or 16 bits	DMA controller
5	16 bits	Open
6	16 bits	Open
7	16 bits	Open

## 2.5 PCI Configuration Space Map

**Table 16. PCI Configuration Space Map**

Bus Number (hex)	Device Number (hex)	Function Number (hex)	Description
00	00	00	Memory controller of Intel 82815 component
00	01	00	PCI to AGP bridge
00	02	00	Intel 82815 GMCH (graphics memory controller hub)/ Intel 82815EP MCH (memory controller hub)
00	1E	00	Hub link to PCI bridge
00	1F	00	Intel 82801BA ICH2 PCI to LPC bridge
00	1F	01	IDE controller
00	1F	02	ICH2 USB controller #1
00	1F	03	SMBus controller
00	1F	04	ICH2 USB controller #2
00	1F	05	AC '97 audio controller (optional)
00	1F	06	AC '97 modem controller (optional)
01	08	00	LAN controller (optional)
01	09	00	PCI bus connector 1 (J7B1)
01	0A	00	PCI bus connector 2 (J8B2)
01	0B	00	PCI bus connector 3 (J9B2)
01	0C	00	PCI bus connector 4 (J9B1)
01	0D	00	PCI bus connector 5 (J10B1)
02 (Note)	00	00	Add-in AGP card

Note: If an add-in AGP card is installed, it occupies PCI Bus 02.

## 2.6 Interrupts

**Table 17. Interrupts**

IRQ	System Resource
NMI	I/O channel check
0	Reserved, interval timer
1	Reserved, keyboard buffer full
2	Reserved, cascade interrupt from slave PIC
3	COM2 (Note)
4	COM1 (Note)
5	LPT2 (Plug and Play option) /Audio/User available
6	Diskette drive
7	LPT1 (Note)
8	Real-time clock
9	Reserved for ICH2 system management bus
10	User available
11	User available
12	Onboard mouse port (if present, else user available)
13	Reserved, math coprocessor
14	Primary IDE (if present, else user available)
15	Secondary IDE (if present, else user available)

Note: Default, but can be changed to another IRQ.

## 2.7 PCI Interrupt Routing Map

This section describes interrupt sharing and how the interrupt signals are connected between the PCI bus connectors and onboard PCI devices. The PCI specification specifies how interrupts can be shared between devices attached to the PCI bus. In most cases, the small amount of latency added by interrupt sharing does not affect the operation or throughput of the devices. In some special cases where maximum performance is needed from a device, a PCI device should not share an interrupt with other PCI devices. Use the following information to avoid sharing an interrupt with a PCI add-in card.

PCI devices are categorized as follows to specify their interrupt grouping:

- **INTA:** By default, all add-in cards that require only one interrupt are in this category. For almost all cards that require more than one interrupt, the first interrupt on the card is also classified as INTA.
- **INTB:** Generally, the second interrupt on add-in cards that require two or more interrupts is classified as INTB. (This is not an absolute requirement.)
- **INTC and INTD:** Generally, a third interrupt on add-in cards is classified as INTC and a fourth interrupt is classified as INTD.

The ICH2 has eight programmable interrupt request (PIRQ) input signals. All PCI interrupt sources either onboard or from a PCI add-in card connect to one of these PIRQ signals. Some PCI interrupt sources are electrically tied together on the D815EEA2 and D815EPEA2 boards and therefore share the same interrupt. Table 18 shows an example of how the PIRQ signals are routed on the D815EEA2 and D815EPEA2 boards.

For example, using Table 18 as a reference, assume that an add-in card using INTA is plugged into PCI bus connector 3. In PCI bus connector 3, INTA is connected to PIRQH, which is already connected to ICH2 USB controller #2. The add-in card in PCI bus connector 3 now shares interrupts with these onboard interrupt sources.

**Table 18. PCI Interrupt Routing Map**

PCI Interrupt Source	ICH PIRQ Signal Name				
	PIRQF	PIRQG	PIRQH	PIRQB	Other
GMCH/AGP				INTB	INTA to PIRQA
ICH2 USB controller #1					INTD to PIRQD
SMBus controller				INTB	
ICH2 USB controller #2			INTC		
ICH2 audio/modem				INTB	
ICH2 LAN					INTA to PIRQE
PCI bus connector 1 (J7B1)	INTA	INTB	INTC	INTD	
PCI bus connector 2 (J8B2)	INTD	INTA	INTB	INTC	
PCI bus connector 3 (J9B2)	INTC	INTD	INTA	INTB	
PCI bus connector 4 (J9B1)	INTB	INTC	INTD	INTA	
PCI bus connector 5 (J10B1)	INTA	INTB	INTC	INTD	

⇒ **NOTE**

*The ICH2 can connect each PIRQ line internally to one of the IRQ signals (3, 4, 5, 6, 7, 10, 11, 12, 14, and 15). Typically, a device that does not share a PIRQ line will have a unique interrupt. However, in certain interrupt-constrained situations, it is possible for two or more of the PIRQ lines to be connected to the same IRQ signal.*

## 2.8 Connectors



### CAUTION

*Only the back panel connectors of the D815EEA2 and D815EPEA2 boards have overcurrent protection. The D815EEA2 and D815EPEA2 boards' internal connectors are not overcurrent protected and should connect only to devices inside the computer's chassis, such as fans and internal peripherals. Do not use these connectors to power devices external to the computer's chassis. A fault in the load presented by an external device may result in a high output current that could damage the board, the interconnecting cable, and the external device itself.*

For information about	Refer to
Overcurrent protection for the board's back panel connectors	Table 19, page 65

This section describes the board's connectors. The connectors can be divided into the following groups:

- Back panel I/O connectors (see page 64)
  - PS/2 keyboard and mouse
  - USB (four)
  - VGA (present only on D815EEA2 boards)
  - Parallel port
  - Serial port A
  - LAN (optional)
  - Audio (line in, line out, and mic in)
- Internal I/O connectors (see page 68)
  - Audio (auxiliary line input, ATAPI CD-ROM, and optional front panel audio)
  - Digital video output (optional; present only on D815EEA2 boards)
  - Fans
  - Power
  - Chassis intrusion (optional)
  - Wake on LAN technology (optional)
  - Add-in boards (one optional CNR connector, one AGP universal connector, and five PCI bus connectors)
  - IDE (two)
  - Diskette drive
- External I/O connectors (see page 78)
  - SCSI LED
  - Serial port B
  - Front panel USB (optional)
  - Front panel (power/sleep/message waiting LED, power switch, hard drive activity LED, reset switch, and auxiliary front panel LED)

## 2.8.1 Back Panel Connectors

Figure 13 shows the location of the back panel connectors on the D815EEA2 and D815EPEA2 boards. The back panel connectors are color-coded in compliance with PC 99 recommendations. The figure legend below lists the colors used.

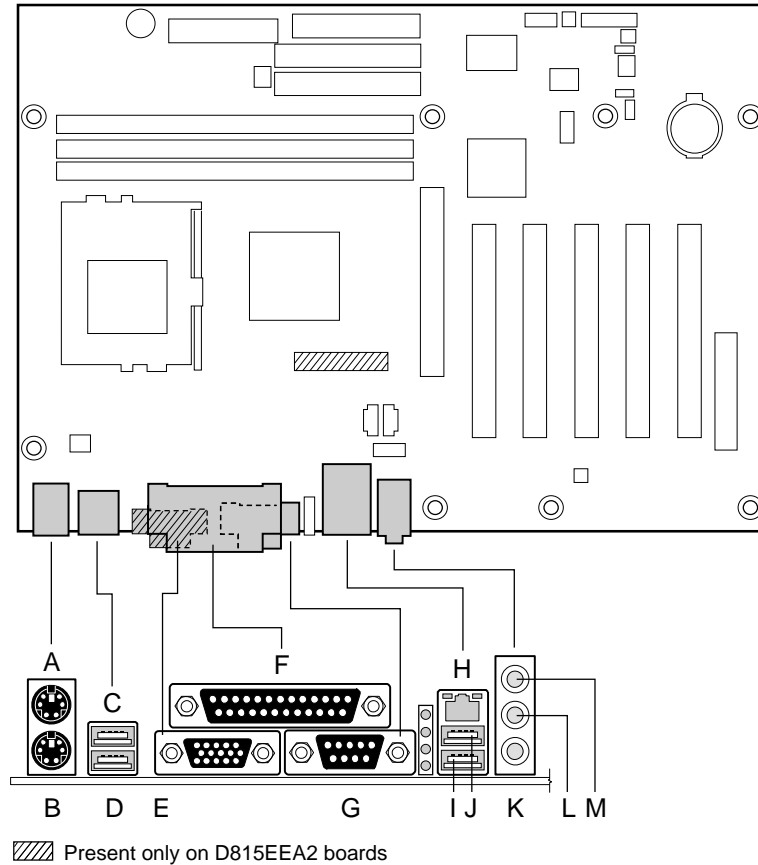

OM11463

Item	Description	Color	For more information see:
A	PS/2 mouse port	Green	Table 20
B	PS/2 keyboard port	Purple	Table 20
C	USB port 1	Black	Table 21
D	USB port 3	Black	Table 21
E	VGA port	Dark blue	Table 22
F	Parallel port	Burgundy	Table 23
G	Serial port A	Teal	Table 24
H	LAN (optional)	Black	Table 25
I	USB port 2	Black	Table 21
J	USB port 0	Black	Table 21
K	Mic in	Pink	Table 26
L	Audio line out	Lime green	Table 27
M	Audio line in	Light blue	Table 28

**Figure 13. Back Panel Connectors**



⇒ **NOTE**

*The back panel audio line out connector is designed to power headphones or amplified speakers only. Poor audio quality occurs if passive (non-amplified) speakers are connected to this output.*

Table 19 lists the overcurrent protection for the D815EEA2 and D815EPEA2 boards. Overcurrent protection is provided to the board’s back panel connectors through thermistors.

**Table 19. Overcurrent Protection for Back Panel Connectors**

Connectors	Maximum Current
PS/2 keyboard and mouse	1.5 A (total for both ports combined)
USB back panel	2.6 A (total for all four ports combined)
VGA	1.5 A

**Table 20. PS/2 Mouse/Keyboard Connectors**

Pin	Signal Name
1	Data
2	Not connected
3	Ground
4	+5 V
5	Clock
6	Not connected

**Table 21. USB Connectors**

Pin	Signal Name
1	+5 V
2	USB_BP0# [USB_BP1#, USB_BP2#, USB_BP3#]
3	USB_BP0 [USB_BP1, USB_BP2, USB_BP3]
4	Ground

Note: Signal names in brackets ([ ]) are for USB ports 1, 2, and 3.

**Table 22. VGA Port Connector (Present Only on D815EEA2 Boards)**

Pin	Signal Name	Pin	Signal Name	Pin	Signal Name
1	Red	6	Ground	11	Not connected
2	Green	7	Ground	12	MONID1
3	Blue	8	Ground	13	HSYNC
4	Not connected	9	+5 V	14	VSYNC
5	Ground	10	Ground	15	MONID2

**Table 23. Parallel Port Connector**

Pin	Standard Signal Name	ECP Signal Name	EPP Signal Name
1	STROBE#	STROBE#	WRITE#
2	PD0	PD0	PD0
3	PD1	PD1	PD1
4	PD2	PD2	PD2
5	PD3	PD3	PD3
6	PD4	PD4	PD4
7	PD5	PD5	PD5
8	PD6	PD6	PD6
9	PD7	PD7	PD7
10	ACK#	ACK#	INTR
11	BUSY	BUSY#, PERIPHACK	WAIT#
12	PERROR	PE, ACKREVERSE#	PE
13	SELECT	SELECT	SELECT
14	AUDOFD#	AUDOFD#, HOSTACK	DATASTB#
15	FAULT#	FAULT#, PERIPHREQST#	FAULT#
16	INIT#	INIT#, REVERSERQST#	RESET#
17	SLCTIN#	SLCTIN#	ADDRSTB#
18 - 25	Ground	Ground	Ground

**Table 24. Serial Port A Connector**

Pin	Signal Name
1	DCD (Data Carrier Detect)
2	RXD# (Receive Data)
3	TXD# (Transmit Data)
4	DTR (Data Terminal Ready)
5	Ground
6	DSR (Data Set Ready)
7	RTS (Request to Send)
8	CTS (Clear to Send)
9	RI (Ring Indicator)

**Table 25. LAN Connector (Optional)**

Pin	Signal Name
1	TX+
2	TX-
3	RX+
4	Ground
5	Ground
6	RX-
7	Ground
8	Ground

**Table 26. Mic In Connector**

Pin	Signal Name
Tip	Mono in
Ring	Mic bias voltage
Sleeve	Ground

**Table 27. Audio Line Out Connector**

Pin	Signal Name
Tip	Audio left out
Ring	Audio right out
Sleeve	Ground

**Table 28. Audio Line In Connector**

Pin	Signal Name
Tip	Audio left in
Ring	Audio right in
Sleeve	Ground

## 2.8.2 Internal I/O Connectors

The internal I/O connectors are divided into the following functional groups:

- Audio, video, power, and hardware control (see page 69)
  - Front panel audio (optional)
  - ATAPI CD-ROM
  - Auxiliary line in
  - Digital video out (optional; present only on D815EEA2 boards)
  - Fans
  - Power
  - Chassis intrusion (optional)
  - Wake on LAN technology (optional)
- Add-in boards and peripheral interfaces (see page 73)
  - CNR (communication and networking riser) (optional)
  - PCI bus (five)
  - AGP Universal
  - IDE (two)
  - Diskette drive

### 2.8.2.1 Expansion Slots

The board has the following ATX-compliant expansion slots:

- One Accelerated Graphics Port (expansion slot 7).
- Three PCI Local Bus connectors (compliant with PCI Rev. 2.2 specification). The SMBus is routed to PCI bus connector 2 (expansion slot 5). PCI add-in cards with SMBus support can access sensor data and other information residing on the desktop board.
- One CNR (optional), shared with PCI bus connector 5 (expansion slot 2).

#### ⇒ NOTE

*This document refers to back-panel slot numbering with respect to processor location on the board. On the board's silkscreen, PCI slots are labeled as PCI 1, PCI 2, PCI 3, PCI 4, and PCI 5, starting with the slot closest to the processor. The CNR slot shares a PCI slot number. The AGP slot is labeled as "AGP" and is not numbered.*

*The ATX/microATX specifications identify expansion slot locations with respect to the far edge of a full-sized ATX chassis. The ATX specification and the board's silkscreen are opposite and could cause confusion. The ATX numbering convention is made without respect to slot type (PCI or AGP), but refers to an actual connector location on a chassis. Figure 15 on page 73 illustrates the board's PCI connector numbering.*

### 2.8.2.2 Audio, Video, Power, and Hardware Control Connectors

Figure 14 shows the location of the audio, video, power, and hardware control connectors on the D815EEA2 and D815EPEA2 boards.

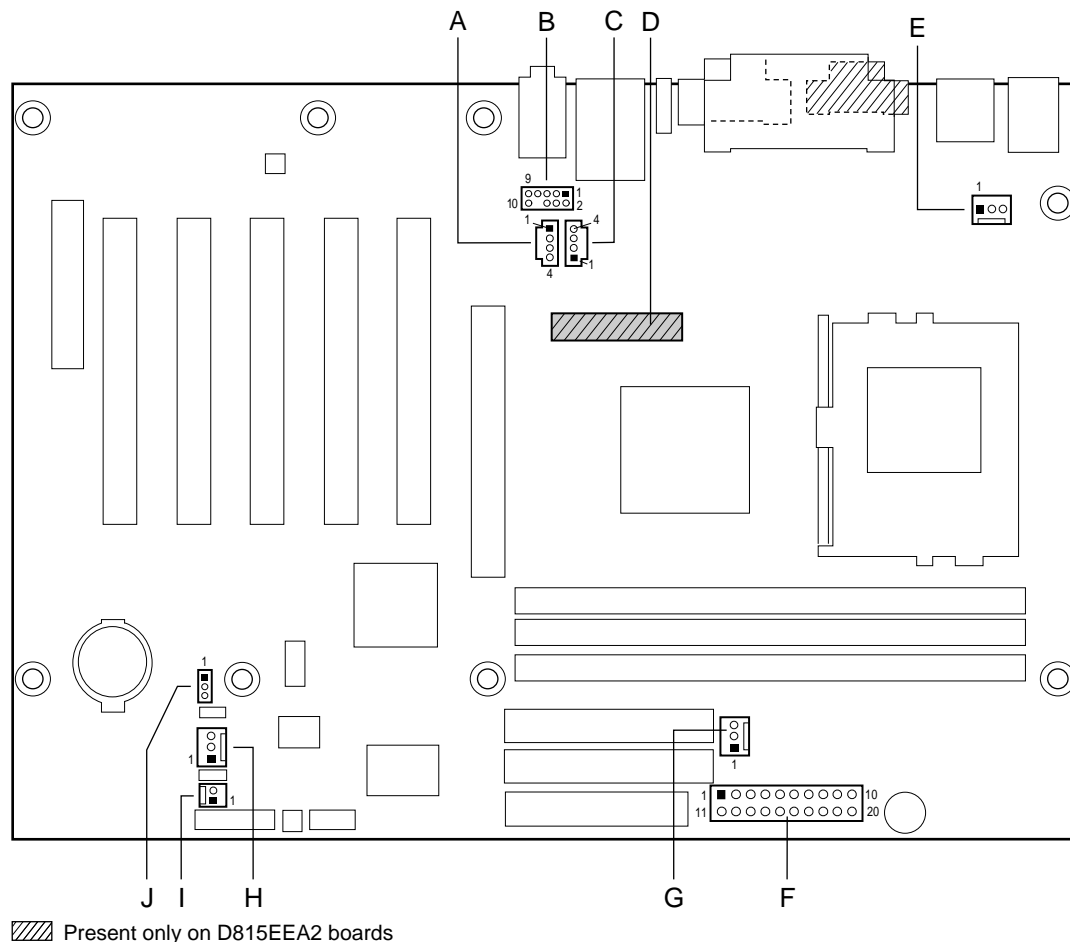

OM11464

Item	Description	Color	Reference Designator	For more information see:
A	Auxiliary line in, ATAPI style	White	J6B4	Table 29
B	Front panel audio (optional)	White	J6B2	Table 30
C	ATAPI CD-ROM	Black	J6B3	Table 31
D	Digital video out (optional)	N/A	J5C1	Table 32
E	Processor fan (fan 1)	N/A	J1B1	Table 33
F	Power	N/A	J4H1	Table 34
G	Chassis fan (fan 3) (optional)	N/A	J4G1	Table 35
H	System fan (fan 2)	N/A	J9H1	Table 36
I	Chassis intrusion (optional)	N/A	J9H3	Table 37
J	Wake on LAN technology (optional)	N/A	J9G1	Table 38

Figure 14. Audio, Video, Power, and Hardware Control Connectors

**Table 29. Auxiliary Line In Connector (J6B4)**

Pin	Signal Name
1	Left auxiliary line in
2	Ground
3	Ground
4	Right auxiliary line in

**Table 30. Front Panel Audio Connector (J6B2) (Optional)**

Pin	Signal Name	Pin	Signal Name
1	MICIN_FP	2	Ground
3	MIC_BIAS	4	AUD_ANALOG
5	AUD_FPOUT_R	6	AUD_RET_R
7	Reserved	8	(Pin removed)
9	AUD_FPOUT_L	10	AUD_RET_L

**⇒ NOTE**

*The front panel audio connector is alternately used as a jumper block for routing audio signals. Refer to Section 2.9.1 on page 82 for more information.*

**Table 31. ATAPI CD-ROM Connector (J6B3)**

Pin	Signal Name
1	Left audio input from CD-ROM
2	CD audio differential ground
3	CD audio differential ground
4	Right audio input from CD-ROM

**Table 32. Digital Video Out Connector (J5C1) (Optional; present only on D815EEA2 boards)**

Pin	Signal Name	Pin	Signal Name
1	LTVCLKIN	2	+5 V
3	P_RST_SLOTS#	4	LTVCL_3V
5	Ground	6	LTVDA_3V
7	Ground	8	LTVVSYNC
9	Ground	10	LTVHSYNC
11	Ground	12	LTVDAT0
13	Ground	14	LTVDAT1
15	Ground	16	LTVDAT2
17	Ground	18	LTVDAT3
19	Ground	20	LTVDAT4
21	Ground	22	LTVDAT5
23	Ground	24	LTVDAT6
25	Ground	26	LTVDAT7
27	Ground	28	LTVDAT8
29	Ground	30	LTVDAT9
31	Ground	32	LTVDAT10
33	Ground	34	LTVDAT11
35	Ground	36	LTVCLKOUT0
37	Ground	38	LTVCLKOUT1
39	Ground	40	LTVBLNK#

**Table 33. Processor Fan Connector (J1B1)**

Pin	Signal Name
1	Ground
2	+12 V
3	FAN1_TACH

**Table 34. Power Connector (J4H1)**

Pin	Signal Name	Pin	Signal Name
1	+3.3 V	11	+3.3 V
2	+3.3 V	12	-12 V
3	Ground	13	Ground
4	+5 V	14	PS-ON# (power supply remote on/off)
5	Ground	15	Ground
6	+5 V	16	Ground
7	Ground	17	Ground
8	PWRGD	18	Not connected
9	+5 V (standby)	19	+5 V
10	+12 V	20	+5 V

**Table 35. Chassis Fan Connector J4G1 (Optional)**

Pin	Signal Name
1	FAN3_PWM
2	+12 V
3	No connect

**Table 36. System Fan Connector (J9H1)**

Pin	Signal Name
1	FAN2_PWM
2	+12 V
3	FAN2_TACH

**Table 37. Chassis Intrusion Connector (J9H3) (Optional)**

Pin	Signal Name
1	INTRUDER#
2	Ground

**Table 38. Wake on LAN Technology Connector (J9G1) (Optional)**

Pin	Signal Name
1	+5 V (standby)
2	Ground
3	WOL

For information about	Refer to
The power connector	Section 1.15.2.1, page 52
The functions of the fan connectors	Section 1.15.2.2, page 53
Wake on LAN technology	Section 1.15.2.3, page 53



### 2.8.2.3 Add-in Board and Peripheral Interface Connectors

Figure 15 shows the location of the add-in board connectors and peripheral interface connectors on the D815EEA2 and D815EPEA2 boards. Note the following considerations for the PCI bus connectors:

- All of the PCI bus connectors are bus master capable.
- SMBus signals are routed to PCI bus connector 2. This enables PCI bus add-in boards with SMBus support to access sensor data on the board. These SMBus signals are as follows:
  - The SMBus clock line is connected to pin A40
  - The SMBus data line is connected to pin A41

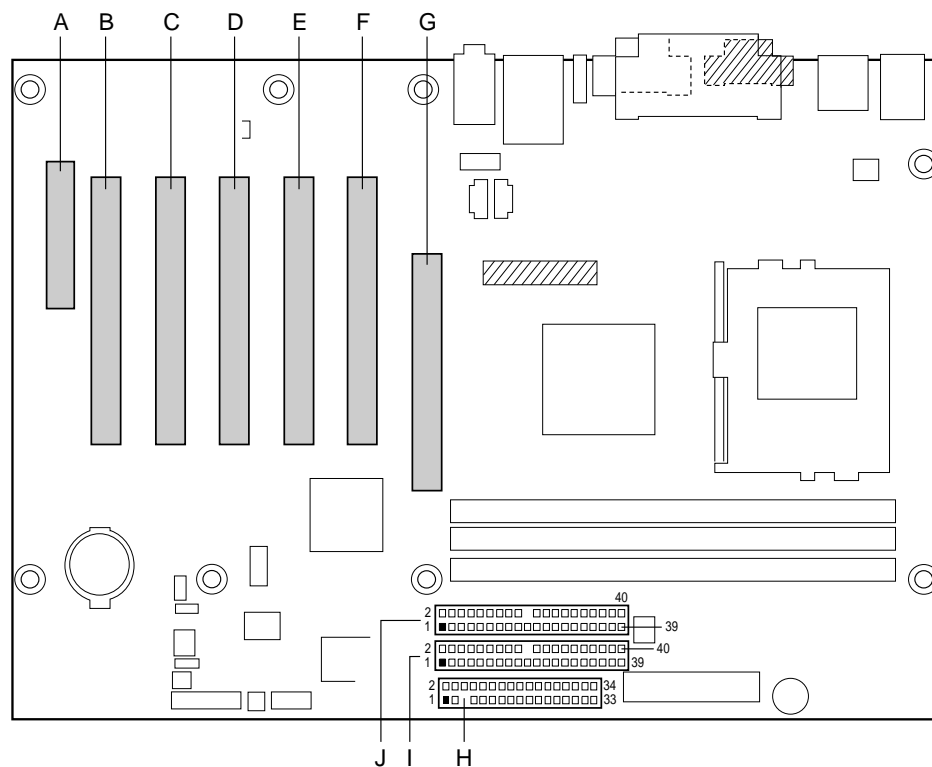

Present only on D815EEA2 boards

OM11465

Item	Description	Reference Designator	For more information see:
A	CNR (optional)	J11B1	Table 39
B	PCI bus connector 5	J10B1	Table 40
C	PCI bus connector 4	J9B1	Table 40
D	PCI bus connector 3	J9B2	Table 40
E	PCI bus connector 2	J8B2	Table 40
F	PCI bus connector 1	J7B1	Table 40
G	AGP universal connector	J6C1	Table 41
H	Diskette drive	J6H2	Table 42
I	Primary IDE	J6H1	Table 43
J	Secondary IDE	J6G2	Table 43

**Figure 15. Add-in Board and Peripheral Interface Connectors**

**Table 39. CNR Connector (J11B1) (Optional)**

Pin	Signal Name	Pin	Signal Name
A1	Reserved	B1	Reserved
A2	Reserved	B2	Reserved
A3	Ground	B3	Reserved
A4	Reserved	B4	Ground
A5	Reserved	B5	Reserved
A6	Ground	B6	Reserved
A7	LAN_TXD2	B7	Ground
A8	LAN_TXD0	B8	LAN_TXD1
A9	Ground	B9	LAN_RSTSYNC
A10	LAN_CLK	B10	Ground
A11	LAN_RXD1	B11	LAN_RXD2
A12	Reserved	B12	LAN_RXD0
A13	USB+ (optional)*	B13	Ground
A14	Ground	B14	Reserved
A15	USB- (optional)*	B15	+5 V (dual)
A16	+12 V	B16	USB_OC (optional)*
A17	Ground	B17	Ground
A18	+3.3 V (dual)	B18	-12 V
A19	+5 V	B19	+3.3 V
A20	Ground	B20	Ground
A21	EEDI	B21	EED0
A22	EECS	B22	EECK
A23	SMB_A1	B23	Ground
A24	SMB_A2	B24	SMB_A0
A25	SMB_SDA	B25	SMB_SCL
A26	AC97_RESET	B26	CDC_DWN_ENAB
A27	Reserved	B27	Ground
A28	AC97_SDATA_IN1	B28	AC97_SYNC
A29	AC97_SDATA_IN0	B29	AC97_SDATA_OUT
A30	Ground	B30	AC97_BITCLK

\* These signals are used only with the optional SMSC LPC47M142 I/O controller. If the SMSC LPC47M132 I/O controller is used, these signals are reserved.

**For information about**

The CNR

**Refer to**

Section 1.14, page 47

**Table 40. PCI Bus Connectors (J7B1, J8B2, J9B2, J9B1, and J10B1)**

Pin	Signal Name	Pin	Signal Name	Pin	Signal Name	Pin	Signal Name
A1	Ground (TRST#)*	B1	-12 V	A32	AD16	B32	AD17
A2	+12 V	B2	Ground (TCK)*	A33	+3.3 V	B33	C/BE2#
A3	+5 V (TMS)*	B3	Ground	A34	FRAME#	B34	Ground
A4	+5 V (TDI)*	B4	Not connected (TDO)*	A35	Ground	B35	IRDY#
A5	+5 V	B5	+5 V	A36	TRDY#	B36	+3.3 V
A6	INTA#	B6	+5 V	A37	Ground	B37	DEVSEL#
A7	INTC#	B7	INTB#	A38	STOP#	B38	Ground
A8	+5 V	B8	INTD#	A39	+3.3 V	B39	LOCK#
A9	Reserved	B9	Not connected (PRSNT1#)*	A40	Reserved **	B40	PERR#
A10	+5 V (I/O)	B10	Reserved	A41	Reserved ***	B41	+3.3 V
A11	Reserved	B11	Not connected (PRSNT2#)*	A42	Ground	B42	SERR#
A12	Ground	B12	Ground	A43	PAR	B43	+3.3 V
A13	Ground	B13	Ground	A44	AD15	B44	C/BE1#
A14	+3.3 V (aux) ****	B14	Reserved	A45	+3.3 V	B45	AD14
A15	RST#	B15	Ground	A46	AD13	B46	Ground
A16	+5 V (I/O)	B16	CLK	A47	AD11	B47	AD12
A17	GNT#	B17	Ground	A48	Ground	B48	AD10
A18	Ground	B18	REQ#	A49	AD09	B49	Ground
A19	PME#	B19	+5 V (I/O)	A50	Key	B50	Key
A20	AD30	B20	AD31	A51	Key	B51	Key
A21	+3.3 V	B21	AD29	A52	C/BE0#	B52	AD08
A22	AD28	B22	Ground	A53	+3.3 V	B53	AD07
A23	AD26	B23	AD27	A54	AD06	B54	+3.3 V
A24	Ground	B24	AD25	A55	AD04	B55	AD05
A25	AD24	B25	+3.3 V	A56	Ground	B56	AD03
A26	IDSEL	B26	C/BE3#	A57	AD02	B57	Ground
A27	+3.3 V	B27	AD23	A58	AD00	B58	AD01
A28	AD22	B28	Ground	A59	+5 V (I/O)	B59	+5 V (I/O)
A29	AD20	B29	AD21	A60	REQ64C#	B60	ACK64C#
A30	Ground	B30	AD19	A61	+5 V	B61	+5 V
A31	AD18	B31	+3.3 V	A62	+5 V	B62	+5 V

\* These signals (in parentheses) are optional in the PCI specification and are not currently implemented.

\*\* On PCI bus connector 2 (J8B2), this pin is connected to the SMBus clock line.

\*\*\* On PCI bus connector 2 (J8B2), this pin is connected to the SMBus data line.

\*\*\*\* During S5 state, this pin is active only on PCI bus connector 2 (J8B2).

**Table 41. AGP Universal Connector (J6C1)**

Pin	Signal Name	Pin	Signal Name	Pin	Signal Name	Pin	Signal Name
A1	+12 V	B1	Not connected	A34	Vddq	B34	Vddq
A2	TYPEDET#	B2	+5 V	A35	AD22	B35	AD21
A3	Reserved	B3	+5 V	A36	AD20	B36	AD19
A4	Not connected	B4	Not connected	A37	Ground	B37	Ground
A5	Ground	B5	Ground	A38	AD18	B38	AD17
A6	INTA#	B6	INTB#	A39	AD16	B39	C/BE2#
A7	RST#	B7	CLK	A40	Vddq	B40	Vddq
A8	GNT1#	B8	REQ#	A41	FRAME#	B41	IRDY#
A9	Vcc3.3	B9	Vcc3.3	A42	Reserved	B42	+3.3 V (aux)
A10	ST1	B10	ST0	A43	Ground	B43	Ground
A11	Reserved	B11	ST2	A44	Reserved	B44	Reserved
A12	PIPE#	B12	RBF#	A45	Vcc3.3	B45	Vcc3.3
A13	Ground	B13	Ground	A46	TRDY#	B46	DEVSEL#
A14	WBF#	B14	Not connected	A47	STOP#	B47	Vddq
A15	SBA1	B15	SBA0	A48	PME#	B48	PERR#
A16	Vcc3.3	B16	Vcc3.3	A49	Ground	B49	Ground
A17	SBA3	B17	SBA2	A50	PAR	B50	SERR#
A18	SBSTB#	B18	SB_STB	A51	AD15	B51	C/BE1#
A19	Ground	B19	Ground	A52	Vddq	B52	Vddq
A20	SBA5	B20	SBA4	A53	AD13	B53	AD14
A21	SBA7	B21	SBA6	A54	AD11	B54	AD12
A22	Reserved	B22	Reserved	A55	Ground	B55	Ground
A23	Ground	B23	Ground	A56	AD9	B56	AD10
A24	Reserved	B24	+3.3 V (aux)	A57	C/BE0#	B57	AD8
A25	Vcc3.3	B25	Vcc3.3	A58	Vddq	B58	Vddq
A26	AD30	B26	AD31	A59	AD_STB0#	B59	AD_STB0
A27	AD28	B27	AD29	A60	AD6	B60	AD7
A28	Vcc3.3	B28	Vcc3.3	A61	Ground	B61	Ground
A29	AD26	B29	AD27	A62	AD4	B62	AD5
A30	AD24	B30	AD25	A63	AD2	B63	AD3
A31	Ground	B31	Ground	A64	Vddq	B64	Vddq
A32	AD_STB1#	B32	AD_STB1	A65	AD0	B65	AD1
A33	C/BE3#	B33	AD23	A66	VREFG_C	B66	VREFC_G

**Table 42. Diskette Drive Connector (J6H2)**

Pin	Signal Name	Pin	Signal Name
1	Ground	2	DENSEL
3	Ground	4	Reserved
5	Key	6	FDEDIN
7	Ground	8	FDINDX# (Index)
9	Ground	10	FDM00# (Motor Enable A)
11	Ground	12	Not connected
13	Ground	14	FDDS0# (Drive Select A)
15	Ground	16	Not connected
17	Not connected	18	FDDIR# (Stepper Motor Direction)
19	Ground	20	FDSTEP# (Step Pulse)
21	Ground	22	FDWD# (Write Data)
23	Ground	24	FDWE# (Write Enable)
25	Ground	26	FDTRK0# (Track 0)
27	Not connected	28	FDWPD# (Write Protect)
29	Ground	30	FDRDATA# (Read Data)
31	Ground	32	FDHEAD# (Side 1 Select)
33	Ground	34	DSKCHG# (Diskette Change)

**Table 43. IDE Connectors (J6H1, Primary and J6G2, Secondary)**

Pin	Signal Name	Pin	Signal Name
1	Reset IDE	2	Ground
3	Data 7	4	Data 8
5	Data 6	6	Data 9
7	Data 5	8	Data 10
9	Data 4	10	Data 11
11	Data 3	12	Data 12
13	Data 2	14	Data 13
15	Data 1	16	Data 14
17	Data 0	18	Data 15
19	Ground	20	Key
21	DDRQ0 [DDRQ1]	22	Ground
23	I/O Write#	24	Ground
25	I/O Read#	26	Ground
27	IOCHRDY	28	Ground
29	DDACK0# [DDACK1#]	30	Ground
31	IRQ 14 [IRQ 15]	32	Reserved
33	DAG1 (Address 1)	34	GPIO_DMA66_Detect_Pri (GPIO_DMA66_Detect_Sec)
35	DAG0 (Address 0)	36	DAG2 (Address 2)
37	Chip Select 1P# [Chip Select 1S#]	38	Chip Select 3P# [Chip Select 3S#]
39	Activity#	40	Ground

Note: Signal names in brackets ([ ]) are for the secondary IDE connector.

### 2.8.3 External I/O Connectors

Figure 16 shows the locations of the external I/O connectors on the D815EEA2 and D815EPEA2 boards.

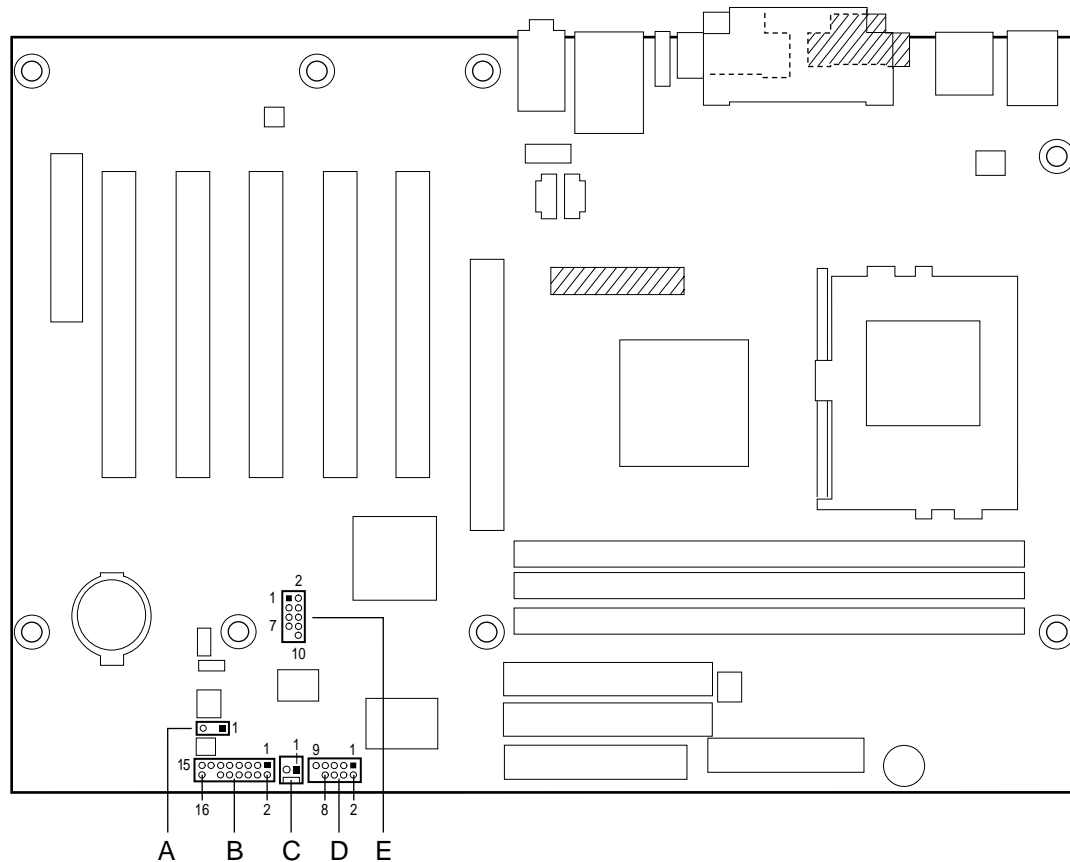

Present only on D815EEA2 boards

OM11466

Item	Description	Reference Designator	For more information see:
A	Auxiliary front panel power LED	J9H2	Table 46
B	Front panel	J9H3	Table 48
C	SCSI LED	J8H2	Table 47
D	Serial port B	J8H1	Table 44
E	Front panel USB (optional)	J8F1	Table 45

Figure 16. External I/O Connectors

**Table 44. Serial Port B Connector (J8H1)**

Pin	Signal Name	Pin	Signal Name
1	DCD2#	2	RXD2 (Receive Data)
3	TXD2 (Transmit Data)	4	DTR2#
5	Ground	6	DSR2#
7	RTS2#	8	CTS2#
9	RI2#	10	Key (no pin)

**Table 45. Front Panel USB Connector (J8F1) (Optional)**

Pin	Signal Name	Pin	Signal Name
1	VREG_FP_USB_PWR	2	VREG_FP_USB_PWR
3	ICH_FP0#	4	ICH_FP1#
5	ICH_FP0	6	ICH_FP1
7	Ground	8	Ground
9	Key (no pin)	10	ICH_U_OC1_2#

⇒ **NOTE**

*A thermistor provides overcurrent protection for the front panel USB connector. The maximum current through this connector is 1.5 A (total for both ports combined).*

**2.8.3.1 Auxiliary Front Panel Power LED Connector**

This connector duplicates the signals on pins 2 and 4 of the front panel connector.

**Table 46. Auxiliary Front Panel Power LED Connector (J9H2)**

Pin	Signal Name	In/Out	Description
1	HDR_BLNK_GRN	Out	Front panel green LED
2	Not connected		
3	HDR_BLNK_YEL	Out	Front panel yellow LED

**2.8.3.2 SCSI Hard Drive Activity LED Connector**

The SCSI hard drive activity LED connector is a 1 x 2-pin connector that allows add-in SCSI host bus adapter to use the same LED as the IDE controller. This connector can be connected to the LED output of the add-in controller card. The LED will indicate when data is being read or written using the add-in controller. Table 47 lists the signal names of the SCSI hard drive activity LED connector.

**Table 47. SCSI LED Connector (J8H2)**

Pin	Signal Name
1	SCSI activity
2	Not connected

### 2.8.3.3 Front Panel Connector

This section describes the functions of the front panel connector. Table 48 lists the signal names of the front panel connector.

**Table 48. Front Panel Connector (J9H3)**

Pin	Signal	In/Out	Description	Pin	Signal	In/Out	Description
1	HD_PWR	Out	Hard disk LED pull-up (330 $\Omega$ ) to +5 V	2	HDR_BLNK_GRN	Out	Front panel green LED
3	HDA#	Out	Hard disk activity LED	4	HDR_BLNK_YEL	Out	Front panel yellow LED
5	GND		Ground	6	FPBUT_IN	In	Power switch
7	FP_RESET#	In	Reset switch	8	GND		Ground
9	+5 V	Out	Power	10	N/C		Not connected
11	N/C		Reserved	12	GND		Ground
13	GND		Ground	14	(pin removed)		Not connected
15	N/C		Reserved	16	+5 V	Out	Power

#### 2.8.3.3.1 Reset Switch Connector

Pins 5 and 7 can be connected to a momentary SPST type switch that is normally open. When the switch is closed, the D815EEA2 and D815EPEA2 boards reset and run the POST.

#### 2.8.3.3.2 Hard Drive Activity LED Connector

Pins 1 and 3 can be connected to an LED to provide a visual indicator that data is being read from or written to a hard drive. For the LED to function properly, an IDE drive must be connected to the onboard IDE interface. The LED will also show activity for devices connected to the SCSI hard drive activity LED connector.

#### For information about

The SCSI hard drive activity LED connector

#### Refer to

Section 2.8.3.2, page 79



### 2.8.3.3.3 Power/Sleep/Message Waiting LED Connector

Pins 2 and 4 can be connected to a single-colored or dual-colored LED. Table 49 shows the possible states for a single-colored LED. Table 50 shows the possible states for a dual-colored LED.

**Table 49. States for a Single-Colored Power LED**

LED State	Description
Off	Power off/sleeping
Steady Green	Running
Blinking Green	Running/message waiting

**Table 50. States for a Dual-Colored Power LED**

LED State	Description
Off	Power off
Steady Green	Running
Blinking Green	Running/message waiting
Steady Yellow	Sleeping
Blinking Yellow	Sleeping/message waiting

⇒ **NOTE**

*To use the message waiting function, ACPI must be enabled in the operating system and a message-capturing application must be invoked.*

### 2.8.3.3.4 Power Switch Connector

Pins 6 and 8 can be connected to a front panel momentary-contact power switch. The switch must pull the SW\_ON# pin to ground for at least 50 ms to signal the power supply to switch on or off. (The time requirement is due to internal debounce circuitry on the D815EEA2 and D815EPEA2 boards.) At least two seconds must pass before the power supply will recognize another on/off signal.

## 2.9 Jumper Blocks



### CAUTION

Do not move any jumpers with the power on. Always turn off the power and unplug the power cord from the computer before changing a jumper setting. Otherwise, the board could be damaged.

Figure 17 shows the locations of the jumper blocks on the D815EEA2 and D815EPEA2 boards.

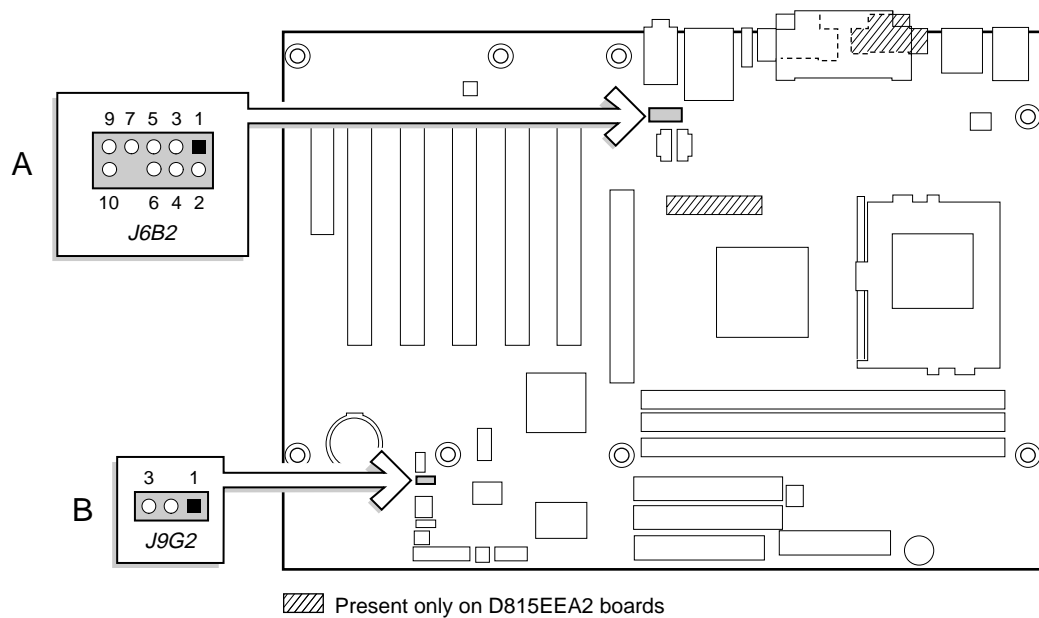

Item	Description	Reference Designator
A	Front panel audio connector / jumper block	J6B2
B	BIOS Setup configuration jumper block	J9G2

Figure 17. Locations of the Jumper Blocks

### 2.9.1 Front Panel Audio Connector/Jumper Block

The connector at location J6B2 has two functions:

- With jumpers installed, the audio line out signals are routed to the back panel audio line out connector.
- With jumpers removed, the connector provides audio line out and mic in signals for front panel audio connectors.

Table 51 describes the two configurations of this connector/jumper block.



### CAUTION

Do not place jumpers on this block in any configuration other than the one described in Table 51. Other jumper configurations are not supported and could damage the board.

**Table 51. Front Panel Audio Connector / Jumper Block (J6B2)**

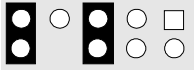
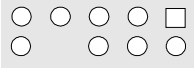
Jumper Setting	Configuration
<p>9 7 5 3 1</p>  <p>10 6 4 2</p> <p>5 and 6, 9 and 10</p>	<p>Audio line out signals are routed to the back panel audio line out connector. The back panel audio line out connector is shown in Figure 13 on page 64.</p>
<p>9 7 5 3 1</p>  <p>10 6 4 2</p> <p>No jumpers installed</p>	<p>Audio line out and mic in signals are available for front panel audio connectors. Table 30 on page 70 lists the names of the signals available on this connector when no jumpers are installed.</p>

⇒ **NOTE**



*When the jumpers are removed and this connector is used for front panel audio, the back panel audio line out and Mic in connectors are disabled.*

## 2.9.2 BIOS Setup Configuration Jumper Block

This 3-pin jumper block determines the BIOS Setup program’s mode. Table 52 describes the jumper settings for the three modes: normal, configure, and recovery.

When the jumper is set to configuration mode and the computer is powered-up, the BIOS compares the CPU version and the microcode version in the BIOS and reports if the two match.

**Table 52. BIOS Setup Configuration Jumper Settings (J9G2)**

Function/Mode	Jumper Setting	Configuration
Normal	1-2 	The BIOS uses current configuration information and passwords for booting.
Configure	2-3 	After the POST runs, Setup runs automatically. The maintenance menu is displayed.
Recovery	None 	The BIOS attempts to recover the BIOS configuration. A recovery diskette is required.

For information about	Refer to
How to access the BIOS Setup program	Section 4.1, page 111
The maintenance menu of the BIOS Setup program	Section 4.2, page 112
BIOS recovery	Section 3.7, page 106

## 2.10 Mechanical Considerations

### 2.10.1 Form Factor

The D815EEA2 and D815EPEA2 boards are designed to fit into a standard ATX-form-factor chassis. Figure 18 illustrates the mechanical form factor for the D815EEA2 and D815EPEA2 boards. Dimensions are given in inches [millimeters]. The outer dimensions are 11.55 inches by 8.20 inches [293.37 millimeters by 208.28 millimeters]. Location of the I/O connectors and mounting holes are in compliance with the ATX specification (see Section 1.4).

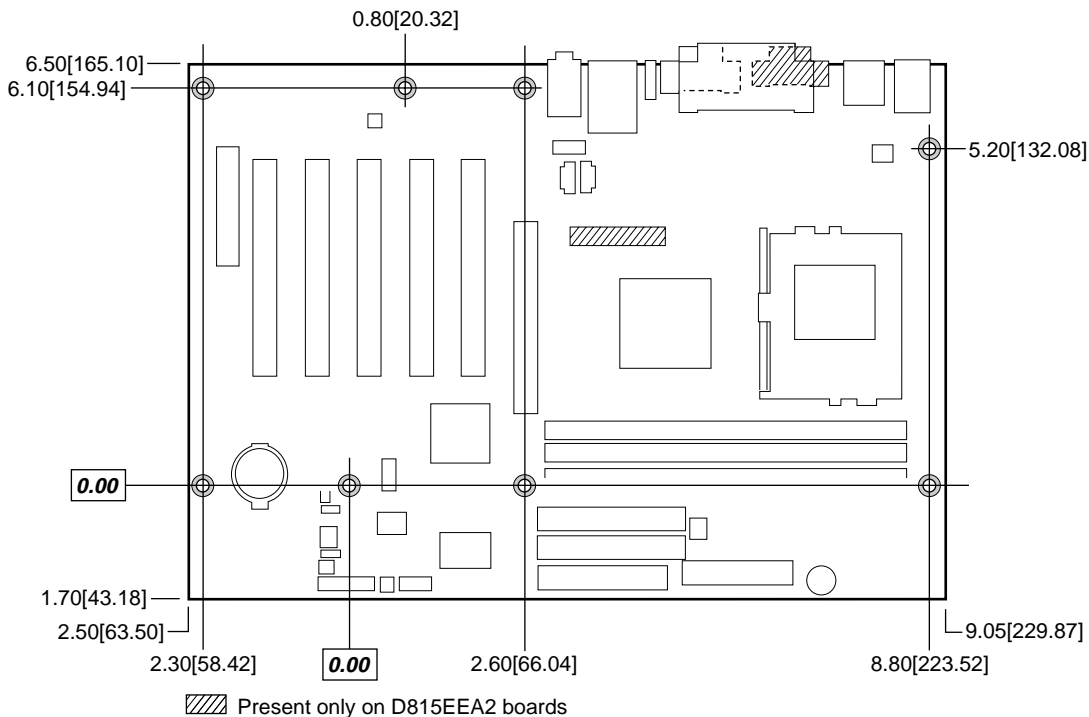

OM11467

Figure 18. Board Dimensions

## 2.10.2 I/O Shields

The back panel I/O shields for the D815EEA2 and D815EPEA2 boards must meet specific dimension and material requirements. Systems based on this board need the back panel I/O shield to pass emissions (EMI) certification testing. Figure 19, Figure 20, and Figure 21 show the critical dimensions of the chassis-dependent I/O shield for the Universal boards. Figure 22, Figure 23, and Figure 24 show the critical dimensions of the chassis-dependent I/O shield for earlier versions of the boards. Dimensions are given in inches [millimeters], to a tolerance of  $\pm 0.020$  inches [0.508 millimeters].

These figures also indicate the position of each cutout. Additional design considerations for I/O shields relative to chassis requirements are described in the ATX specification.

For information about	Refer to
The ATX specification	Table 4, page 19

### ⇒ NOTE

*An I/O shield compliant with the ATX chassis specification 2.03 is available from Intel.*

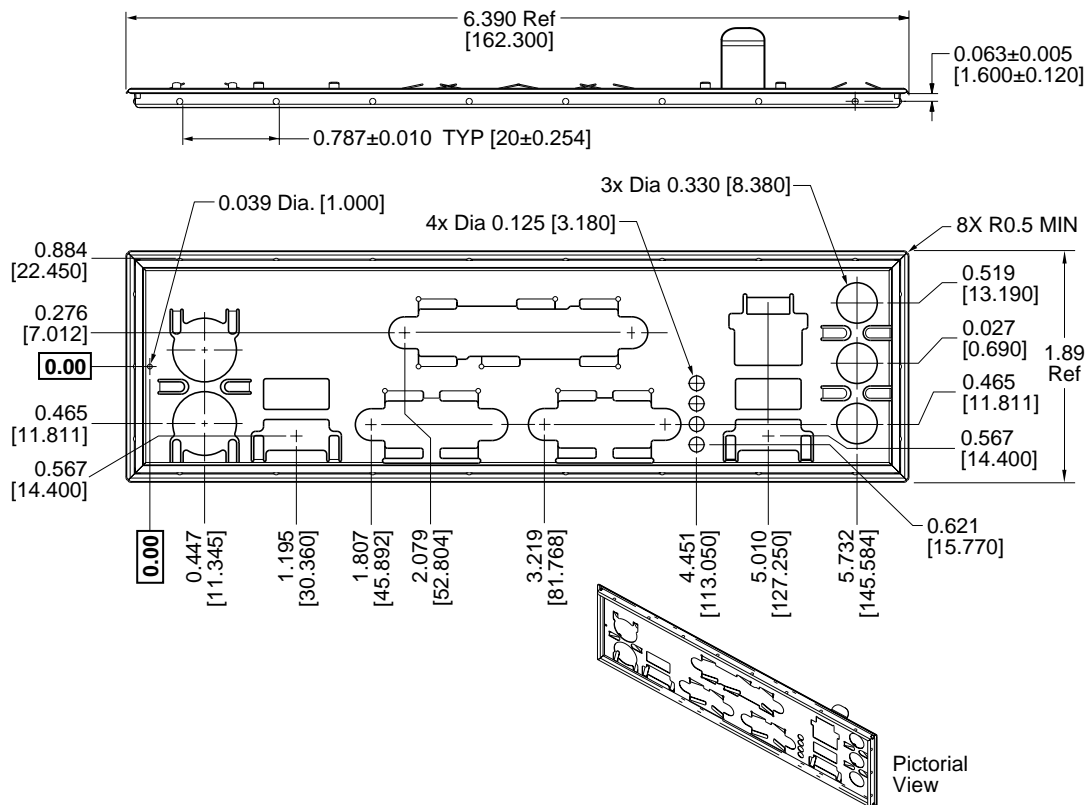

OM11400

Figure 19. I/O Shield Dimensions  
(for D815EEA2 Universal Boards with Onboard LAN Subsystem)

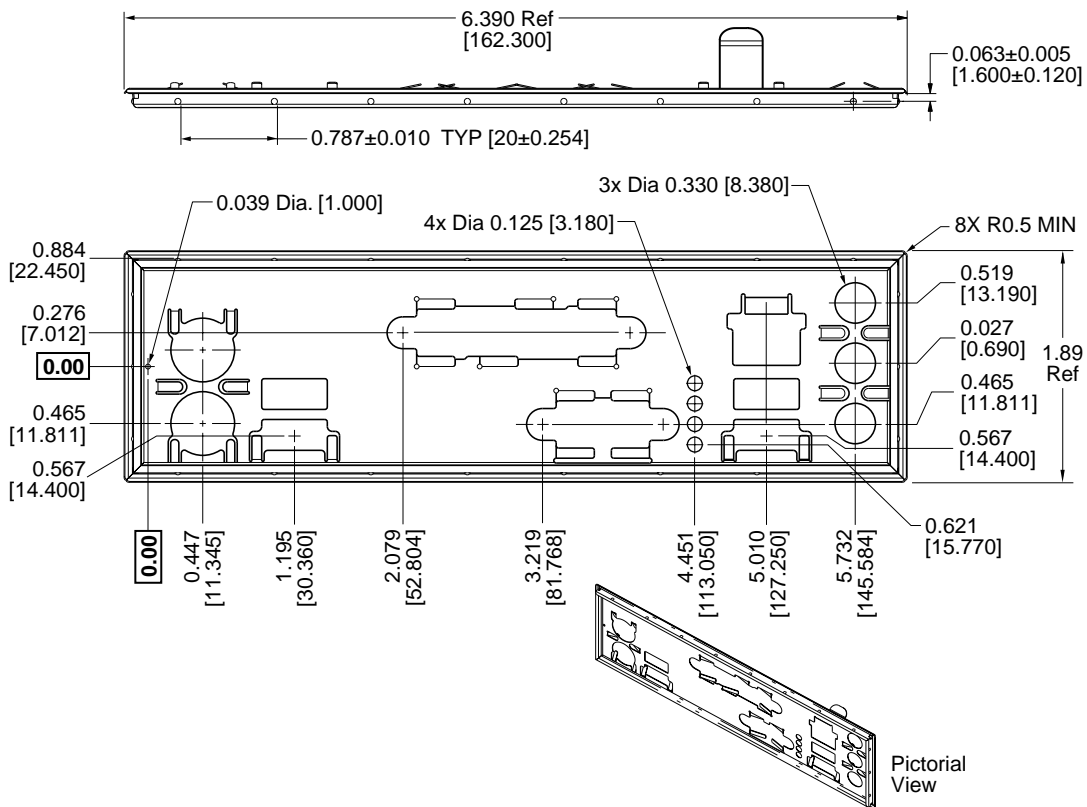

OM11400A

**Figure 20. I/O Shield Dimensions  
(for D815EPEA2 Universal Boards with Onboard LAN Subsystem)**

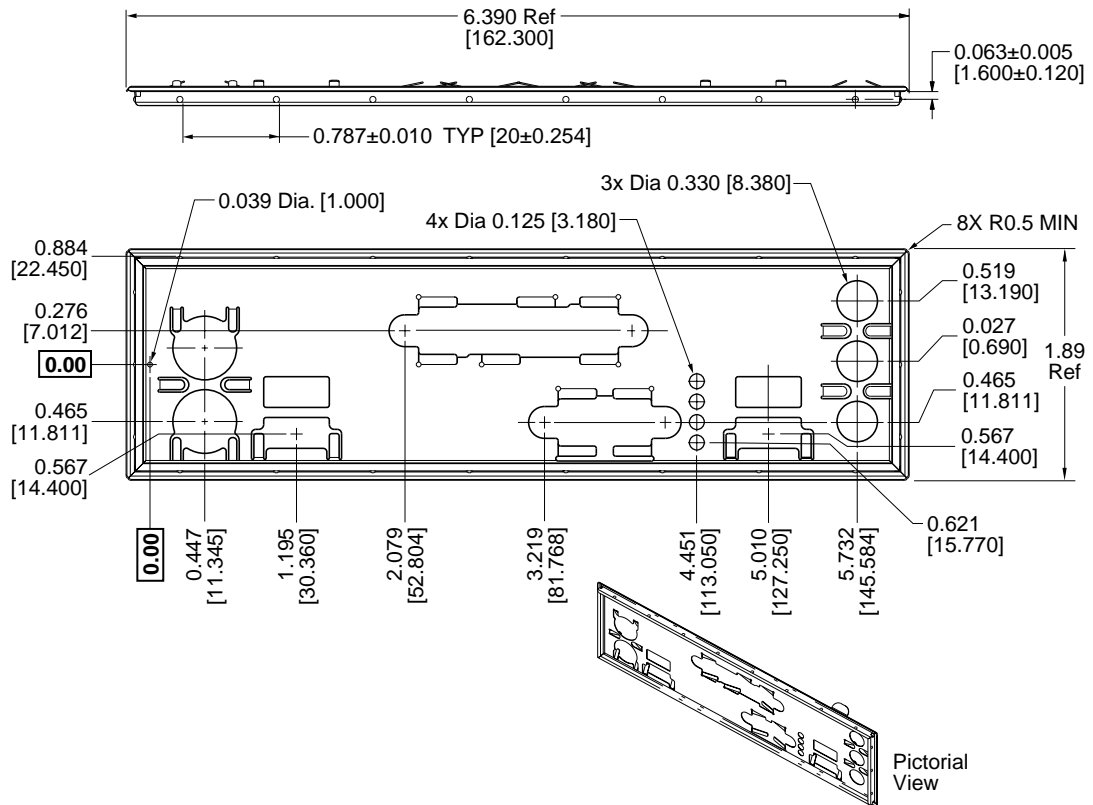

OM11400B

**Figure 21. I/O Shield Dimensions  
(for D815EPEA2 Universal Boards without Onboard LAN Subsystem)**



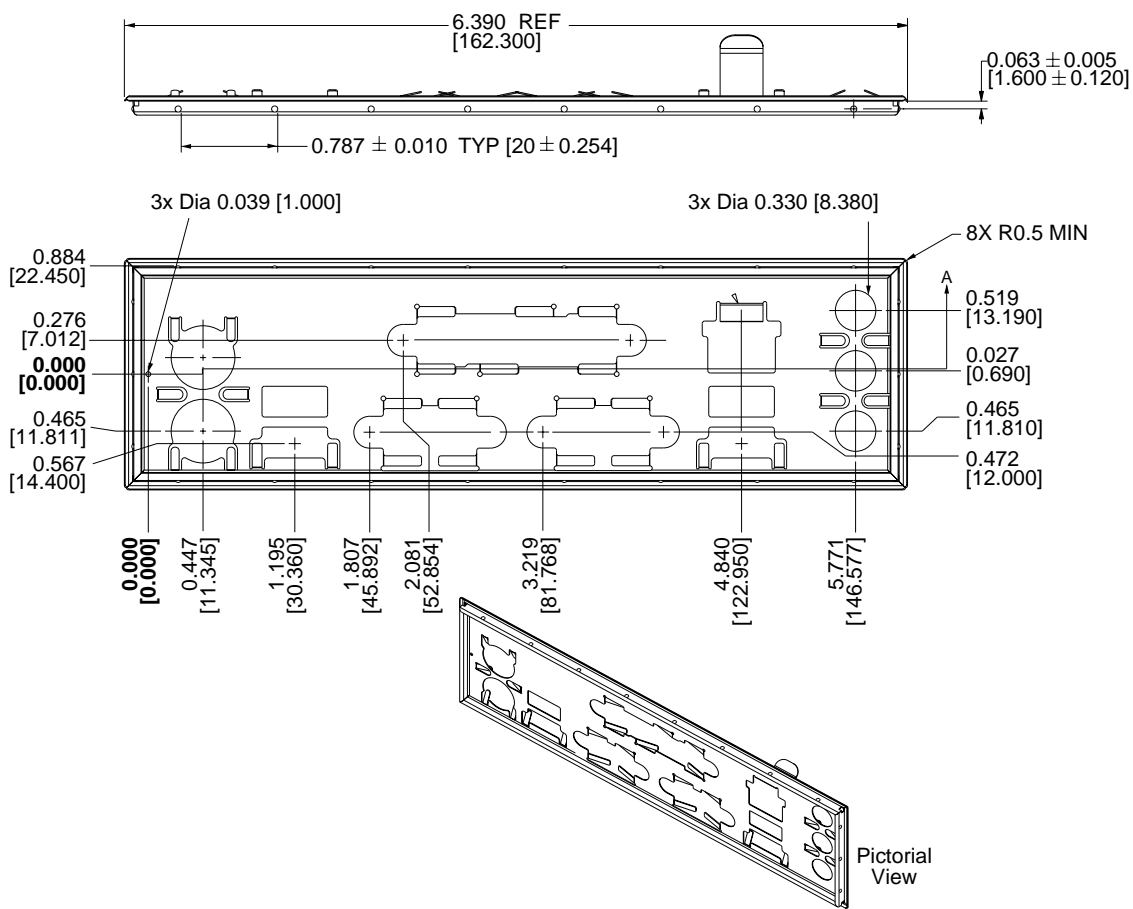

OM11487

**Figure 22. I/O Shield Dimensions  
(for D815EEA2 Boards with Onboard LAN Subsystem)**

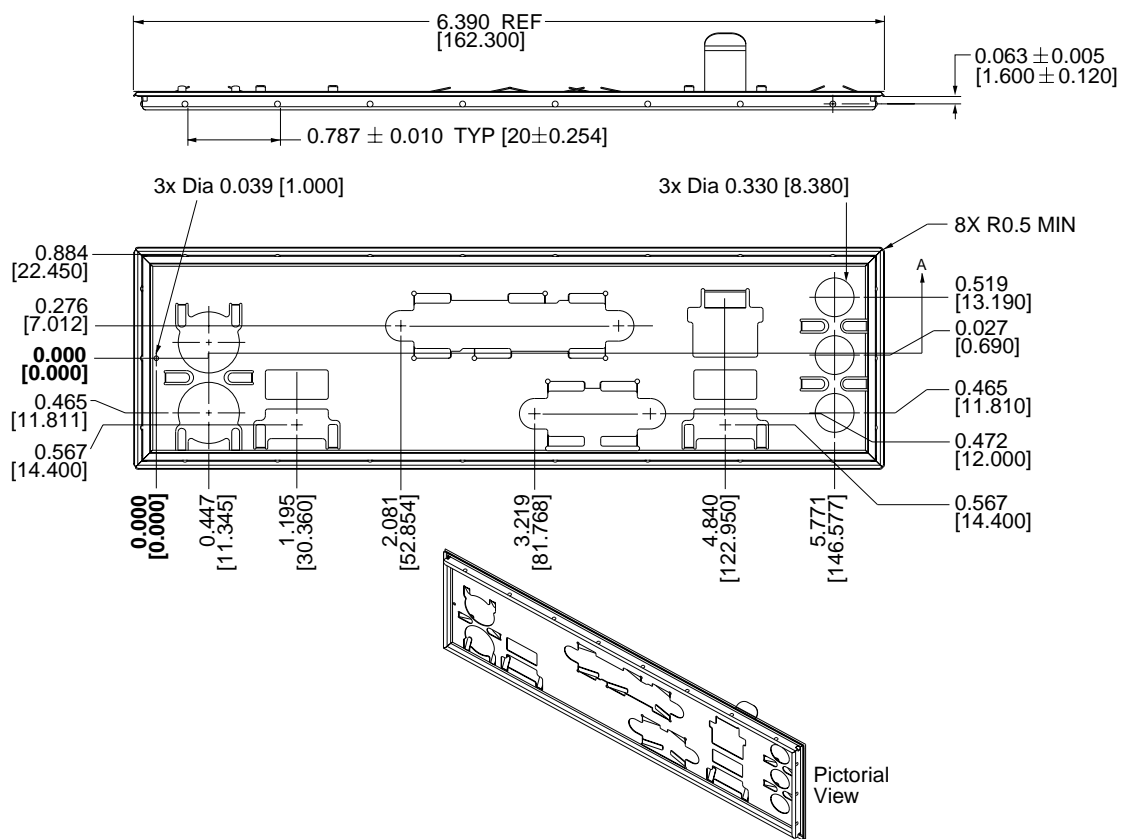

OM11485

**Figure 23. I/O Shield Dimensions  
(for D815EPEA2 Boards with Onboard LAN Subsystem)**

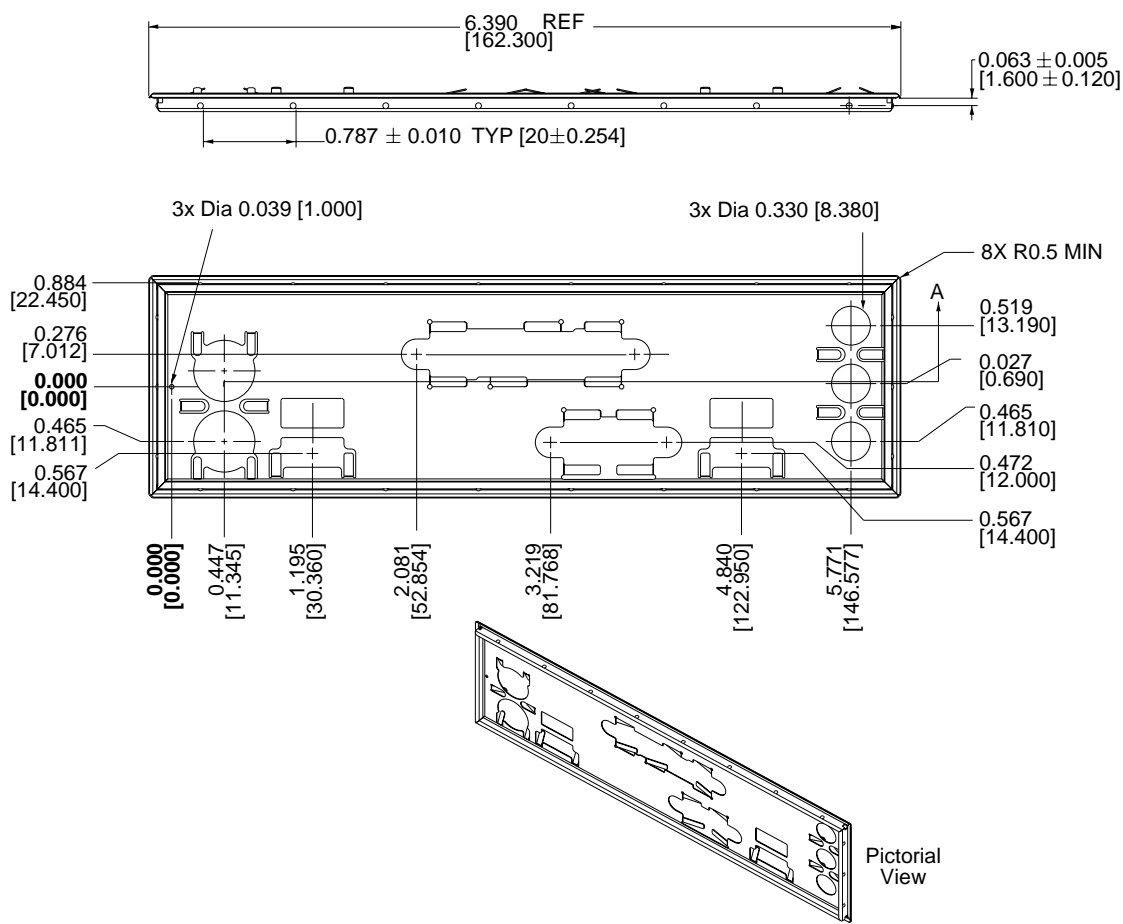

OM11486

**Figure 24. I/O Shield Dimensions  
(for D815EPEA2 Boards without Onboard LAN Subsystem)**

## 2.11 Electrical Considerations

### 2.11.1 Power Consumption

Table 53 lists voltage and current measurements for a computer that contains either the D815EEA2 or the D815EPEA2 board and the following:

- 800 MHz Intel Pentium III processor with a 256 KB cache
- 128 MB SDRAM
- 3.5-inch diskette drive
- 6.4 GB ATA-33 IDE hard disk drive
- 6x IDE DVD-ROM drive

This information is provided only as a guide for calculating approximate power usage with additional resources added.

Values for the Windows 98 desktop mode are measured at 640 x 480 x 256 colors and 60 Hz refresh rate. AC watts are measured with the computer is connected to a typical 200 W power supply, at nominal input voltage and frequency, with a true RMS wattmeter at the line input.

#### ⇒ **NOTE**

*Actual system power consumption depends upon system configuration. The power supply should comply with the recommendations found in the ATX Form Factor Specification document (see Table 4 on page 20 for specification information).*

Table 53 lists the power usage for a D815EEA2 board with the configuration listed on the previous page and including the optional onboard LAN subsystem.

**Table 53. Power Usage for a D815EEA2 Board with Onboard LAN**

Mode	AC Power	DC Current at:				
		+3.3 V	+5 V	+12 V	-12 V	+5 V (standby)
Windows 98 SE APM full on	54 W	2.02 A	3.22 A	0.18 A	0.00 A	0.26 A
Windows 98 SE APM standby	29 W	1.58 A	0.50 A	0.18 A	0.00 A	0.04 A
Windows 98 SE ACPI S0	33 W	1.68 A	0.26 A	0.18 A	0.00 A	0.26 A
Windows 98 SE ACPI S1	28 W	1.58 A	0.48 A	0.18 A	0.00 A	0.18 A
Windows 98 SE ACPI S3	1 W	0.00 A	0.00 A	0.00 A	0.00 A	0.22 A

Table 54 lists the power usage for a D815EPEA2 board with the configuration listed on the previous page, but without the optional onboard LAN subsystem and with an add-in 2x 4 MB AGP graphics card.

**Table 54. Power Usage for a D815EPEA2 Board with Add-in Graphics Card, without Onboard LAN**

Mode	AC Power	DC Current at:				
		+3.3 V	+5 V	+12 V	-12 V	+5 V (standby)
Windows 98 SE APM full on	55 W	2.45 A	3.40 A	0.20 A	0.00 A	0.12 A
Windows 98 SE APM standby	34 W	2.28 A	0.50 A	0.20 A	0.00 A	0.09 A
Windows 98 SE ACPI S0	35 W	2.42 A	0.51 A	0.20 A	0.00 A	0.11 A
Windows 98 SE ACPI S1	29 W	2.28 A	0.49 A	0.20 A	0.00 A	0.09 A
Windows 98 SE ACPI S3	1 W	0.00 A	0.00 A	0.00 A	0.00 A	0.12 A

## 2.11.2 Add-in Board Considerations

The D815EEA2 and D815EPEA2 boards are designed to provide 2 A (average) of +5 V current for each add-in board. The total +5 V current draw for add-in boards in a fully-loaded D815EEA2 and D815EPEA2 boards (all six expansion slots filled) must not exceed 12 A.

## 2.11.3 Standby Current Requirements



### CAUTION

*Power supplies used with the board must provide enough standby current to support the Instantly Available (ACPI S3 sleep state) configuration. If the standby current necessary to support multiple wake events from the PCI and/or USB buses exceeds power supply capacity, the board may lose register settings stored in memory and may not awaken properly.*

To estimate the standby current required for a specific system configuration, the standby current requirements of all installed components must be combined. Refer to Table 55 and follow these steps:

1. List the board's +5 V standby current requirement (810 mA).
2. List the PS/2 ports' standby current requirement (see note below).
3. List, from the AGP and PCI 2.2 slots (wake-enabled devices) row, the total number of wake-enabled devices installed and multiply by the standby current requirement.
4. List, from the AGP and PCI 2.2 slots (non-wake-enabled devices) row, the total number of wake-enabled devices installed and multiply by the standby current requirement.
5. List all additional wake-enabled devices' and non-wake-enabled devices' standby current requirements as applicable.
6. Add all the listed standby current totals from steps 1 through 5 to determine the total estimated standby current power supply requirement.

**Table 55. Standby Current Requirements**

Description	Standby Current Requirements (mA) <sup>(Note 1)</sup>
Total for the board	810
Onboard LAN (optional)	95
Wake on LAN technology connector (optional) connected to wake-enabled PCI LAN card	525
PS/2 ports <sup>(Note 2)</sup>	345
AGP and PCI 2.2 slots (wake-enabled devices) <sup>(Note 2)</sup>	510
AGP and PCI 2.2 slots (non-wake-enabled devices) <sup>(Note 2)</sup>	155
USB ports <sup>(Note 2)</sup>	507.5
CNR (optional) <sup>(Note 2)</sup>	375

Notes:

1. These values were measured in a power static state.
2. Dependent upon system configuration. See the note on the following page.

⇒ **NOTE**

*AGP and PCI requirements are calculated by totaling the following:*

- *One wake-enabled device @ 375 mA*
- *Three non-wake-enabled devices @ 20 mA each*

*PS/2 Ports requirements per the IBM PS/2 Port Specification (Sept 1991):*

- *Keyboard @ 275 mA (Actual measurements are 220 mA-300 mA, depending on the type of keyboard and the operational state of the keyboard's LEDs.)*
- *Mouse @ 70 mA*

*USB requirements are calculated by totaling the following:*

- *One wake-enabled device @ 500 mA*
- *Three USB non-wake-enabled devices @ 2.5 mA each*

*The USB ports are limited to a combined total of 700 mA.*

*CNR requirements are calculated as follows:*

- *One wake-enabled device @ 375 mA*
- *Non-wake-enabled devices @ 20 mA*

### 2.11.4 Fan Connector Current Capability

The D815EEA2 and D815EPEA2 boards are designed to supply a maximum of 225 mA per fan connector.

### 2.11.5 Power Supply Considerations



**CAUTION**

*The +5 V standby line for the power supply must be capable of providing adequate +5 V standby current. Failure to do so can damage the power supply. The total amount of standby current required depends on the wake devices supported and manufacturing options. Refer to Section 2.11.3 on page 94 for additional information.*

System integrators should refer to the power usage values listed in Section 2.11.1, on page 92 when selecting a power supply for use with either the D815EEA2 or D815EPEA2 board.

Measurements account only for current sourced by either the D815EEA2 or D815EPEA2 board while running in idle modes of the started operating systems.

Additional power required will depend on configurations chosen by the integrator.

The power supply must comply with the following recommendations found in the indicated sections of the ATX form factor specification.

- The potential relation between 3.3 VDC and +5 VDC power rails (Section 4.2)
- The current capability of the +5 VSB line (Section 4.2.1.2)
- All timing parameters (Section 4.2.1.3)
- All voltage tolerances (Section 4.2.2)

**For information about**

The ATX form factor specification

**Refer to**

Table 4, page 20

## 2.12 Thermal Considerations



### CAUTION

An ambient temperature that exceeds the board's maximum operating temperature by 10 °C could cause components to exceed their maximum case temperature and malfunction. For information about the maximum operating temperature, see the environmental specifications in Section 2.14.



### CAUTION

The processor voltage regulator area (item A in Figure 25) can reach a temperature of up to 85 °C in an open chassis. System integrators should ensure that proper airflow is maintained in the voltage regulator circuit. Failure to do so may result in damage to the voltage regulator circuit.

Figure 25 shows the locations of the localized high temperature zones for the D815EEA2 and D815EPEA2 boards.

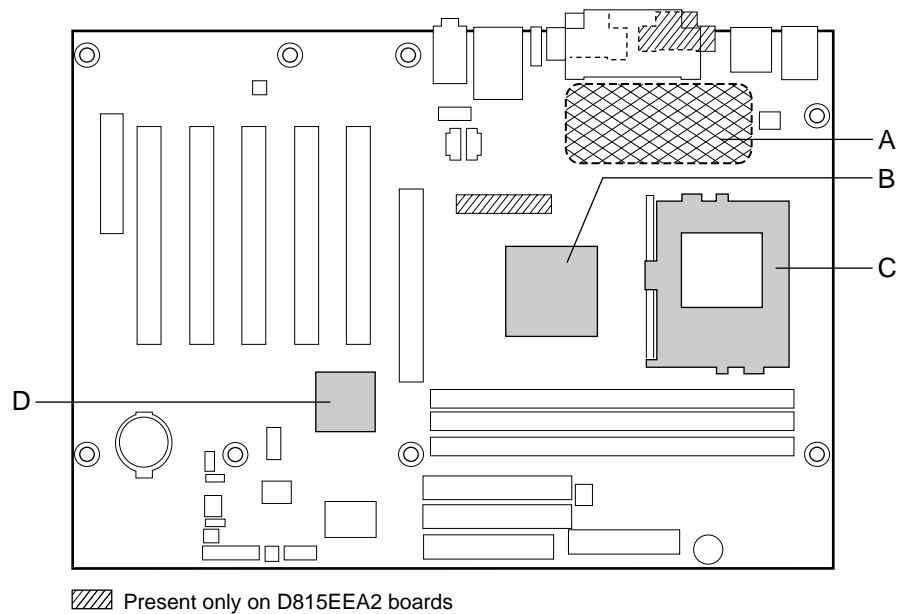

OM11468

- A Processor voltage regulator area
- B
  - Intel 82815 Graphics and Memory Controller Hub (GMCH) (D815EEA2 boards)
  - Intel 82815EP Memory Controller Hub (MCH) (D815EPEA2 boards)
- C Processor
- D Intel 82801BA ICH2

**Figure 25. Localized High Temperature Zones**



Table 56 provides maximum case temperatures for D815EEA2 and D815EPEA2 board components that are sensitive to thermal changes. Case temperatures could be affected by the operating temperature, current load, or operating frequency. Maximum case temperatures are important when considering proper airflow to cool the D815EEA2 and D815EPEA2 boards.

**Table 56. Thermal Considerations for Components**

Component	Maximum Case Temperature
Intel Pentium III processor	For processor case temperature, see processor datasheets and processor specification updates
Intel Celeron processor	
Intel 82815 GMCH/ Intel 82815EP MCH	116 °C (under bias)
Intel 82801BA ICH2	109 °C (under bias)

For information about	Refer to
Intel Pentium III processor datasheets and specification updates	Section 1.3, page 19
Intel Celeron processor datasheets and specification updates	Section 1.3, page 19

## 2.13 Reliability

The mean time between failures (MTBF) prediction is calculated using component and subassembly random failure rates. The calculation is based on the Bellcore Reliability Prediction Procedure, TR-NWT-000332, Issue 4, September 1991. The MTBF prediction is used to estimate repair rates and spare parts requirements.

The Mean Time Between Failures (MTBF) data is calculated from predicted data at 35 °C.

D815EEA2 and D815EPEA2 boards' MTBF: 355,748 hours.

## 2.14 Environmental

Table 57 lists the environmental specifications for the D815EEA2 and D815EPEA2 boards.

**Table 57. D815EEA2 and D815EPEA2 Board Environmental Specifications**

Parameter	Specification		
<b>Temperature</b>			
Non-Operating	-40 °C to +70 °C		
Operating	0 °C to +55 °C		
<b>Shock</b>			
Unpackaged	30 g trapezoidal waveform		
	Velocity change of 170 inches/second		
Packaged	Half sine 2 millisecond		
	Product Weight (pounds)	Free Fall (inches)	Velocity Change (inches/sec)
	<20	36	167
	21-40	30	152
	41-80	24	136
	81-100	18	118
<b>Vibration</b>			
Unpackaged	5 Hz to 20 Hz : 0.01 g <sup>2</sup> Hz sloping up to 0.02 g <sup>2</sup> Hz		
	20 Hz to 500 Hz: 0.02 g <sup>2</sup> Hz (flat)		
Packaged	10 Hz to 40 Hz: 0.015 g <sup>2</sup> Hz (flat)		
	40 Hz to 500 Hz: 0.015 g <sup>2</sup> Hz sloping down to 0.00015 g <sup>2</sup> Hz		

## 2.15 Regulatory Compliance

This section describes the D815EEA2 and D815EPEA2 boards' compliance with U.S. and international safety and electromagnetic compatibility (EMC) regulations.

### 2.15.1 Safety Regulations

Table 58 lists the safety regulations the D815EEA2 and D815EPEA2 boards comply with when correctly installed in a compatible host system.

**Table 58. Safety Regulations**

Regulation	Title
UL 1950/CSA C22.2 No. 950, 3 <sup>rd</sup> edition	Bi-National Standard for Safety of Information Technology Equipment including Electrical Business Equipment. (USA and Canada)
EN 60950, 2 <sup>nd</sup> Edition, 1992 (with Amendments 1, 2, 3, and 4)	The Standard for Safety of Information Technology Equipment including Electrical Business Equipment. (European Union)
IEC 60950, 2 <sup>nd</sup> Edition, 1991 (with Amendments 1, 2, 3, and 4)	The Standard for Safety of Information Technology Equipment including Electrical Business Equipment. (International)
EMKO-TSE (74-SEC) 207/94	Summary of Nordic deviations to EN 60950. (Norway, Sweden, Denmark, and Finland)

### 2.15.2 EMC Regulations

Table 59 lists the EMC regulations the D815EEA2 and D815EPEA2 boards comply with when correctly installed in a compatible host system.

**Table 59. EMC Regulations**

Regulation	Title
FCC (Class B)	Title 47 of the Code of Federal Regulations, Parts 2 and 15, Subpart B, Radiofrequency Devices. (USA)
ICES-003 (Class B)	Interference-Causing Equipment Standard, Digital Apparatus. (Canada)
EN55022: 1994 (Class B)	Limits and methods of measurement of Radio Interference Characteristics of Information Technology Equipment. (European Union)
EN55024: 1998	Information Technology Equipment – Immunity Characteristics Limits and methods of measurement. (European Union)
AS/NZS 3548 (Class B)	Australian Communications Authority, Standard for Electromagnetic Compatibility. (Australia and New Zealand)
CISPR 22, 2 <sup>nd</sup> Edition (Class B)	Limits and methods of measurement of Radio Disturbance Characteristics of Information Technology Equipment. (International)
CISPR 24: 1997	Information Technology Equipment – Immunity Characteristics – Limits and Methods of Measurements. (International)

### 2.15.3 Product Certification Markings (Board Level)

The D815EEA2 and D815EPEA2 desktop boards have the following product certification markings:

- UL joint US/Canada Recognized Component mark: Consists of lower case c followed by a stylized backward UR and followed by a small US. Includes adjacent UL file number for Intel desktop boards: E210882 (component side).
- FCC Declaration of Conformity logo mark for Class B equipment; to include Intel name and D815EEA2 and D815EPEA2 model designation (solder side).
- CE mark: Declaring compliance to European Union (EU) EMC directive (89/336/EEC) and Low Voltage directive (73/23/EEC) (component side). The CE mark should also be on the shipping container.
- Australian Communications Authority (ACA) C-Tick mark: consists of a stylized C overlaid with a check (tick) mark (component side), followed by Intel supplier code number, N-232. The C-tick mark should also be on the shipping container.
- Korean EMC certification logo mark: consists of MIC lettering within a stylized elliptical outline.
- Printed wiring board manufacturer's recognition mark: consists of a unique UL recognized manufacturer's logo, along with a flammability rating (94V-0) (solder side).
- PB part number: Intel bare circuit board part number (solder side) A45133-002. Also includes SKU number starting with AA followed by additional alphanumeric characters.
- Battery "+ Side Up" marking: located on the component side of the board in close proximity to the battery holder.

# 3 Overview of BIOS Features

---

## What This Chapter Contains

- 3.1 Introduction.....101
- 3.2 BIOS Flash Memory Organization .....102
- 3.3 Resource Configuration .....102
- 3.4 System Management BIOS (SMBIOS) .....103
- 3.5 Legacy USB Support .....104
- 3.6 BIOS Updates.....105
- 3.7 Recovering BIOS Data .....106
- 3.8 Boot Options.....107
- 3.9 Fast Booting Systems with Intel® Rapid BIOS Boot .....107
- 3.10 BIOS Security Features .....109

### 3.1 Introduction

The D815EEA2 and D815EPEA2 boards use an Intel/AMI BIOS that is stored in the Firmware Hub (FWH) and can be updated using a disk-based program. The FWH contains the BIOS Setup program, POST, APM, the PCI auto-configuration utility, and Plug and Play support.

The D815EEA2 and D815EPEA2 boards support system BIOS shadowing, allowing the BIOS to execute from 64-bit onboard write-protected DRAM.

The BIOS displays a message during POST identifying the type of BIOS and a revision code. The initial production BIOS is identified as EA81520A.86A.

When the D815EEA2 or D815EPEA2 board’s jumper is set to configuration mode and the computer is powered-up, the BIOS compares the CPU version and the microcode version in the BIOS and reports if the two match.

<b>For information about</b>	<b>Refer to</b>
The D815EEA2 and D815EPEA2 boards’ compliance level with APM and Plug and Play	Table 4, page 20

## 3.2 BIOS Flash Memory Organization

The FWH (an SST 49LF004A) includes a 4 Mbit (512 KB) symmetrical flash memory device. Internally, the device is grouped into eight 64-KB blocks that are individually erasable, lockable, and unlockable.

## 3.3 Resource Configuration

### 3.3.1 PCI Autoconfiguration

The BIOS can automatically configure PCI devices. PCI devices may be onboard or add-in cards. Autoconfiguration lets a user insert or remove PCI cards without having to configure the system. When a user turns on the system after adding a PCI card, the BIOS automatically configures interrupts, the I/O space, and other system resources. Any interrupts set to Available in Setup are considered to be available for use by the add-in card.

PCI interrupts are distributed to available ISA interrupts that have not been assigned to system resources. The assignment of PCI interrupts to ISA IRQs is non-deterministic. PCI devices can share an interrupt, but an ISA device cannot share an interrupt allocated to PCI or to another ISA device. Autoconfiguration information is stored in ESCD format.

For information about the versions of PCI and Plug and Play supported by the BIOS, see Section 1.4.

### 3.3.2 IDE Support

If you select Auto in the BIOS Setup program, the BIOS automatically sets up the two IDE connectors with independent I/O channel support. The IDE interface supports hard drives up to ATA-66/100 and recognizes any ATAPI devices, including CD-ROM drives, tape drives, and Ultra DMA drives (see Section 1.4 for the supported version of ATAPI). The BIOS determines the capabilities of each drive and configures them to optimize capacity and performance. To take advantage of the high capacities typically available today, hard drives are automatically configured for Logical Block Addressing (LBA) and to PIO Mode 3 or 4, depending on the capability of the drive. You can override the auto-configuration options by specifying manual configuration in the BIOS Setup program.

To use ATA-66/100 features the following items are required:

- An ATA-66/100 peripheral device
- An ATA-66/100 compatible cable
- ATA-66/100 operating system device drivers

#### ⇒ NOTE

*ATA-66/100 compatible cables are backward compatible with drives using slower IDE transfer protocols. If an ATA-66/100 disk drive and a disk drive using any other IDE transfer protocol are attached to the same cable, the maximum transfer rate between the drives is reduced to that of the slowest drive.*

#### ⇒ NOTE

*Do not connect an ATA device as a slave on the same IDE cable as an ATAPI master device. For example, do not connect an ATA hard drive as a slave to an ATAPI CD-ROM drive.*

### 3.4 System Management BIOS (SMBIOS)

SMBIOS is a Desktop Management Interface (DMI) compliant method for managing computers in a managed network.

The main component of SMBIOS is the management information format (MIF) database, which contains information about the computing system and its components. Using SMBIOS, a system administrator can obtain the system types, capabilities, operational status, and installation dates for system components. The MIF database defines the data and provides the method for accessing this information. The BIOS enables applications such as Intel® LANDesk® Client Manager to use SMBIOS. The BIOS stores and reports the following SMBIOS information:

- BIOS data, such as the BIOS revision level
- Fixed-system data, such as peripherals, serial numbers, and asset tags
- Resource data, such as memory size, cache size, and processor speed
- Dynamic data, such as event detection and error logging

Non-Plug and Play operating systems, such as Windows NT, require an additional interface for obtaining the SMBIOS information. The BIOS supports an SMBIOS table interface for such operating systems. Using this support, an SMBIOS service-level application running on a non-Plug and Play operating system can obtain the SMBIOS information.

For information about	Refer to
The D815EEA2 and D815EPEA2 boards' compliance level with the SMBIOS specification	Table 4, page 20

## 3.5 Legacy USB Support

Legacy USB support enables USB devices such as keyboards, mice, and hubs to be used even when the operating system's USB drivers are not yet available. Legacy USB support is used to access the BIOS Setup program, and to install an operating system that supports USB. By default, legacy USB support is set to Enabled.

Legacy USB support operates as follows:

1. When you apply power to the computer, legacy support is disabled.
2. POST begins.
3. Legacy USB support is enabled by the BIOS allowing you to use a USB keyboard to enter and configure the BIOS Setup program and the maintenance menu.
4. POST completes.
5. The operating system loads. While the operating system is loading, USB keyboards, mice, and hubs are recognized and may be used to configure the operating system. (Keyboards, mice, and hubs are not recognized during this period if legacy USB support was set to Disabled in the BIOS Setup program.)

To install an operating system that supports USB, verify that legacy USB support in the BIOS Setup program is set to Enabled and follow the operating system's installation instructions.

### ⇒ **NOTE**

*Legacy USB support is for keyboards, mice, and hubs only. Other USB devices are not supported in legacy mode.*



## 3.6 BIOS Updates

The BIOS can be updated using either of the following utilities, which are available on the Intel World Wide Web site:

- Intel® Express BIOS Update utility, which enables automated updating while in the Windows environment. Using this utility, the BIOS can be updated from a file on a hard disk, a 1.44 MB diskette, or a CD-ROM, or from the file location on the Web.
- Intel® Flash Memory Update Utility, which requires creation of a boot diskette and manual rebooting of the system. Using this utility, the BIOS can be updated from a file on a 1.44 MB diskette (from a legacy diskette drive or an LS-120 diskette drive) or a CD-ROM.

Both utilities support the following BIOS maintenance functions:

- Verifying that the updated BIOS matches the target system to prevent accidentally installing an incompatible BIOS.
- Updating both the BIOS boot block and the main BIOS. This process is fault tolerant to prevent boot block corruption.
- Updating the BIOS boot block separately.
- Changing the language section of the BIOS.
- Updating replaceable BIOS modules, such as the video BIOS module.
- Inserting a custom splash screen.

### ⇒ NOTE

*Review the instructions distributed with the upgrade utility before attempting a BIOS update.*

For information about	Refer to
The Intel World Wide Web site	Section 1.3, page 19

### 3.6.1 Language Support

The BIOS Setup program and help messages are available in five languages: US English, German, Italian, French, and Spanish. The default language is US English, which is present unless another language is selected.

### 3.6.2 Custom Splash Screen

During POST, an Intel splash screen is displayed by default. This splash screen can be replaced with a custom splash screen. A utility is available from Intel to assist with creating a custom splash screen. The custom splash screen can be programmed into the flash memory using the BIOS upgrade utility. Information about this capability is available on the Intel Support World Wide Web site.

For information about	Refer to
The Intel World Wide Web site	Section 1.3, page 19

## 3.7 Recovering BIOS Data

Some types of failure can destroy the BIOS. For example, the data can be lost if a power outage occurs while the BIOS is being updated in flash memory. The BIOS can be recovered from a diskette using the BIOS recovery mode. When recovering the BIOS, be aware of the following:

- Because of the small amount of code available in the non-erasable boot block area, there is no video support. You can only monitor this procedure by listening to the speaker or looking at the diskette drive LED.
- The recovery process may take several minutes; larger BIOS flash memory devices require more time.
- Two beeps and the end of activity in the diskette drive indicate successful BIOS recovery.
- A series of continuous beeps indicates a failed BIOS recovery.

To create a BIOS recovery diskette, a bootable diskette must be created and the BIOS update files copied to it. BIOS upgrades and the Intel Flash Memory Upgrade utility are available from Intel Customer Support through the Intel World Wide Web site.

### ⇒ NOTE

*If the computer is configured to boot from an LS-120 diskette (in the Setup program's Removable Devices submenu), the BIOS recovery diskette must be a standard 1.44 MB diskette not a 120 MB diskette.*

For information about	Refer to
The BIOS recovery mode jumper settings	Section 2.9.2, page 82
The Boot menu in the BIOS Setup program	Section 4.7, page 130
Contacting Intel customer support	Section 1.3, page 19

## 3.8 Boot Options

In the BIOS Setup program, the user can choose to boot from a diskette drive, hard drives, CD-ROM, or the network. The default setting is for the diskette drive to be the first boot device, the hard drive second, and the ATAPI CD-ROM third. The fourth device is disabled.

### 3.8.1 CD-ROM and Network Boot

Booting from CD-ROM is supported in compliance to the El Torito bootable CD-ROM format specification. Under the Boot menu in the BIOS Setup program, ATAPI CD-ROM is listed as a boot device. Boot devices are defined in priority order. If the CD-ROM is selected as the boot device, it must be the first device with bootable media.

The network can be selected as a boot device. This selection allows booting from a network add-in card with a remote boot ROM installed.

For information about	Refer to
The El Torito specification	Table 4, page 20

### 3.8.2 Booting without Attached Devices

For use in embedded applications, the BIOS has been designed so that after passing the POST, the operating system loader is invoked even if the following devices are not present:

- Video adapter
- Keyboard
- Mouse

## 3.9 Fast Booting Systems with Intel® Rapid BIOS Boot

There are three factors that affect system boot speed:

- Selecting and configuring peripherals properly
- Using an optimized BIOS, such as the Intel Rapid BIOS
- Selecting a compatible operating system

The BIOS is not configured by default to boot at the fastest possible speed. Empirical measurements have shown that some Intel Desktop boards, when optimized as described above, can complete POST (Power-On Self-Test) in six seconds or less and boot to an active Microsoft Windows Me operating system in 21 seconds.

### 3.9.1 Peripheral Selection and Configuration

The following techniques will help speed system boot:

- Choose a hard drive with parameters such as “power-up to data ready” less than eight seconds to minimize hard drive startup delays. The Western Digital Caviar<sup>†</sup> AA or BA series are examples of drives that meet this parameter.
- Select a CD-ROM drive with a fast initialization rate; variations can influence POST times.
- Eliminate unnecessary features such as video-company-logo displaying, screen repaints, or mode changes. These all add time in the boot process. The Plug and Play communication between the video BIOS and the monitor shows time variances.
- Try different monitors. Some monitors initialize more quickly, thereby enabling the system to boot more quickly.

### 3.9.2 Intel Rapid BIOS Boot

There are several BIOS settings that, if adjusted, can reduce the execution time of the POST:

- Set the hard disk drive as the first boot device. As a result, the POST will not seek a diskette drive (saving about one second from the POST time) or a CD-ROM drive (saving about two seconds).
- Make sure that Quiet Boot is disabled, to eliminate the logo splash screen. This could save several seconds of painting complex graphic images and changing video modes.
- Make sure the Intel Rapid BIOS Boot option (in the Boot menu of the BIOS Setup Program) is enabled (this is typically the default setting). This feature bypasses memory count and floppy seek.
- Disable the LAN feature PXE (Preboot eXecutable Environment) if it will not be used. Doing so can reduce up to four seconds of option ROM boot time.

#### ⇒ NOTE

*It is possible to optimize the boot process to the point where the system boots so quickly that the Intel Logo Screen (or a custom logo splash screen) will not be seen. Monitors and hard disk drives with minimum initialization times can also contribute to a boot time that might be so fast that necessary logo screens and POST messages cannot be seen. If this should occur, it is possible to introduce a programmable delay ranging from 3 to 30 seconds using the Hard Disk Pre-Delay feature in the IDE Configuration Submenu of the BIOS Setup Program.*

For information about	Refer to
IDE Configuration Submenu in the BIOS Setup Program	Table 70, page 120

### 3.9.3 Operating System Selection

The Microsoft Windows Me operating system has built-in capabilities for making PCs boot more quickly. To speed operating system availability at boot time, limit the number of applications that load into the system tray or the task bar.

## 3.10 BIOS Security Features

The BIOS includes security features that restrict access to the BIOS Setup program and who can boot the computer. A supervisor password and a user password can be set for the BIOS Setup program and for booting the computer, with the following restrictions:

- The supervisor password gives unrestricted access to view and change all the Setup options in the BIOS Setup program. This is the supervisor mode.
- The user password gives restricted access to view and change Setup options in the BIOS Setup program. This is the user mode.
- If only the supervisor password is set, pressing the <Enter> key at the password prompt of the BIOS Setup program allows the user restricted access to Setup.
- If both the supervisor and user passwords are set, users can enter either the supervisor password or the user password to access Setup. Users have access to Setup respective to which password is entered.
- Setting the user password restricts who can boot the computer. The password prompt will be displayed before the computer is booted. If only the supervisor password is set, the computer boots without asking for a password. If both passwords are set, the user can enter either password to boot the computer.

Table 60 shows the effects of setting the supervisor password and user password. This table is for reference only and is not displayed on the screen.

**Table 60. Supervisor and User Password Functions**

Password Set	Supervisor Mode	User Mode	Setup Options	Password to Enter Setup	Password During Boot
Neither	Can change all options <small>(Note)</small>	Can change all options <small>(Note)</small>	None	None	None
Supervisor only	Can change all options	Can change a limited number of options	Supervisor Password	Supervisor	None
User only	N/A	Can change all options	Enter Password Clear User Password	User	User
Supervisor and user set	Can change all options	Can change a limited number of options	Supervisor Password Enter Password	Supervisor or user	Supervisor or user

Note: If no password is set, any user can change all Setup options.

### For information about

Setting user and supervisor passwords

### Refer to

Section 4.5, page 126



# 4 BIOS Setup Program

---

## What This Chapter Contains

4.1	Introduction.....	111
4.2	Maintenance Menu .....	112
4.3	Main Menu.....	114
4.4	Advanced Menu.....	115
4.5	Security Menu.....	126
4.6	Power Menu .....	127
4.7	Boot Menu.....	130
4.8	Exit Menu .....	133

### 4.1 Introduction

The BIOS Setup program can be used to view and change the BIOS settings for the computer. The BIOS Setup program is accessed by pressing the <F2> key after the Power-On Self-Test (POST) memory test begins and before the operating system boot begins. The menu bar is shown below.

Maintenance	Main	Advanced	Security	Power	Boot	Exit
-------------	------	----------	----------	-------	------	------

Table 61 lists the BIOS Setup program menu features.

**Table 61. BIOS Setup Program Menu Bar**

Maintenance	Main	Advanced	Security	Power	Boot	Exit
Clears passwords and BIS credentials and enables extended configuration mode	Allocates resources for hardware components	Configures advanced features available through the chipset	Sets passwords and security features	Configures power management features	Selects boot options	Saves or discards changes to Setup program options

#### ⇒ NOTE

*In this chapter, all examples of the BIOS Setup program menu bar include the maintenance menu; however, the maintenance menu is displayed only when the board is in configuration mode. Section 2.9 on page 82 tells how to put the board in configuration mode.*

Table 62 lists the function keys available for menu screens.

**Table 62. BIOS Setup Program Function Keys**

BIOS Setup Program Function Key	Description
<←> or <→>	Selects a different menu screen (Moves the cursor left or right)
<↑> or <↓>	Selects an item (Moves the cursor up or down)
<Tab>	Selects a field (Not implemented)
<Enter>	Executes command or selects the submenu
<F9>	Load the default configuration values for the current menu
<F10>	Save the current values and exits the BIOS Setup program
<Esc>	Exits the menu

## 4.2 Maintenance Menu

To access this menu, select Maintenance on the menu bar at the top of the screen.

Maintenance	Main	Advanced	Security	Power	Boot	Exit
Extended Configuration						

The menu shown in Table 63 is for clearing Setup passwords and enabling extended configuration mode. Setup only displays this menu in configuration mode. See Section 2.9 on page 82 for configuration mode setting information.

**Table 63. Maintenance Menu**

Feature	Options	Description
Clear All Passwords	<ul style="list-style-type: none"> <li>• <b>Yes (default)</b></li> <li>• No</li> </ul>	Clears the user and administrative passwords.
Clear BIS Credentials	<ul style="list-style-type: none"> <li>• <b>Yes (default)</b></li> <li>• No</li> </ul>	Clears the Wired for Management Boot Integrity Service (BIS) credentials.
Extended Configuration	No options	Invokes the Extended Configuration submenu.
CPU Microcode Update Revision	No options	Displays CPU's Microcode Update Revision.
CPU Stepping Signature	No options	Displays CPU's Stepping Signature.



## 4.2.1 Extended Configuration Submenu

To access this submenu, select Maintenance on the menu bar, then Extended Configuration.

<b>Maintenance</b>	Main	Advanced	Security	Power	Boot	Exit
<b>Extended Configuration</b>						

The submenu represented by Table 64 is for setting video memory cache mode. This submenu becomes available when User Defined is selected under Extended Configuration.

**Table 64. Extended Configuration Submenu**

Feature	Options	Description
Extended Configuration	<ul style="list-style-type: none"> <li>• <b>Default (default)</b></li> <li>• User-Defined</li> </ul>	<i>User Defined</i> allows setting memory control and video memory cache mode. If selected here, will also display in the Advanced Menu as: "Extended Menu: <i>Used</i> ."
Video Memory Cache Mode	<ul style="list-style-type: none"> <li>• USWC</li> <li>• <b>UC (default)</b></li> </ul>	Selects Uncacheable Speculative Write-Combining (USWC) video memory cache mode. Full 32 byte contents of the Write Combining buffer are written to memory as required. Cache lookups are not performed. Both the video driver and the application must support Write Combining.  Selects UnCacheable (UC) video memory cache mode. This setting identifies the video memory range as uncacheable by the processor. Memory writes are performed in program order. Cache lookups are not performed. Well suited for applications not supporting Write Combining.
SDRAM Auto-Configuration	<ul style="list-style-type: none"> <li>• <b>Auto (default)</b></li> <li>• User Defined</li> </ul>	Sets extended memory configuration options to <i>Auto</i> or <i>User Defined</i> .
CAS# Latency	<ul style="list-style-type: none"> <li>• 3</li> <li>• 2</li> <li>• <b>Auto (default)</b></li> </ul>	Selects the number of clock cycles required to address a column in memory.
SDRAM RAS# to CAS# Delay	<ul style="list-style-type: none"> <li>• 3</li> <li>• 2</li> <li>• <b>Auto (default)</b></li> </ul>	Selects the number of clock cycles between addressing a row and addressing a column.
SDRAM RAS# Precharge	<ul style="list-style-type: none"> <li>• 3</li> <li>• 2</li> <li>• <b>Auto (default)</b></li> </ul>	Selects the length of time required before accessing a new row.

## 4.3 Main Menu

To access this menu, select Main on the menu bar at the top of the screen.

Maintenance	<b>Main</b>	Advanced	Security	Power	Boot	Exit
-------------	-------------	----------	----------	-------	------	------

Table 65 describes the Main Menu. This menu reports processor and memory information and is for configuring the system date and system time.

**Table 65. Main Menu**

Feature	Options	Description
BIOS Version	No options	Displays the version of the BIOS.
Processor Type	No options	Displays processor type.
Processor Speed	No options	Displays processor speed.
System Bus Frequency	No options	Displays the system bus frequency.
Cache RAM	No options	Displays the size of second-level cache.
Total Memory	No options	Displays the total amount of RAM.
Memory Bank 0 Memory Bank 1 Memory Bank 2	No options	Displays the amount and type of RAM in the memory banks.
Language	<ul style="list-style-type: none"> <li>• <b>English (default)</b></li> <li>• Espanol</li> </ul>	Selects the current default language used by the BIOS.
Processor Serial Number	<ul style="list-style-type: none"> <li>• <b>Disabled (default)</b></li> <li>• Enabled</li> </ul>	Enables and disables the processor serial number. (Present only when a Pentium III processor is installed)
System Time	Hour, minute, and second	Specifies the current time.
System Date	Day of week month/day/year	Specifies the current date.

## 4.4 Advanced Menu

To access this menu, select Advanced on the menu bar at the top of the screen.

Maintenance	Main	<b>Advanced</b>	Security	Power	Boot	Exit
		PCI Configuration				
		Boot Configuration				
		Peripheral Configuration				
		IDE Configuration				
		Diskette Configuration				
		Event Log Configuration				
		Video Configuration				

Table 66 describes the Advanced Menu. This menu is used for setting advanced features that are available through the chipset.

**Table 66. Advanced Menu**

Feature	Options	Description
Extended Configuration	No options	If <i>Used</i> is displayed, <i>User-Defined</i> has been selected in Extended Configuration under the Maintenance Menu.
PCI Configuration	No options	Configures individual PCI slot's IRQ priority. When selected, displays the PCI Configuration submenu.
Boot Configuration	No options	Configures Plug and Play and the Numlock key, and resets configuration data. When selected, displays the Boot Configuration submenu.
Peripheral Configuration	No options	Configures peripheral ports and devices. When selected, displays the Peripheral Configuration submenu.
IDE Configuration	No options	Specifies type of connected IDE device.
Diskette Configuration	No options	When selected, displays the Diskette Configuration submenu.
Event Log Configuration	No options	Configures Event Logging. When selected, displays the Event Log Configuration submenu.
Video Configuration	No options	Configures video features. When selected, displays the Video Configuration submenu.

### 4.4.1 PCI Configuration Submenu

To access this submenu, select Advanced on the menu bar, then PCI Configuration.

Maintenance	Main	<b>Advanced</b>	Security	Power	Boot	Exit
		<b>PCI Configuration</b>				
		Boot Configuration				
		Peripheral Configuration				
		IDE Configuration				
		Diskette Configuration				
		Event Log Configuration				
		Video Configuration				

The submenu represented by Table 67 is for configuring the IRQ priority of PCI slots individually.

**Table 67. PCI Configuration Submenu**

Feature	Options	Description
PCI Slot 1 IRQ Priority	<ul style="list-style-type: none"> <li>• <b>Auto (default)</b></li> <li>9</li> <li>10</li> <li>11</li> </ul>	Allows selection of IRQ priority. IRQ Priority selections for PCI slots 1 and 5 are linked. Selections made to PCI Slot 1 IRQ Priority are repeated in PCI Slot 5 IRQ Priority.
PCI Slot 2 IRQ Priority	<ul style="list-style-type: none"> <li>• <b>Auto (default)</b></li> <li>9</li> <li>10</li> <li>11</li> </ul>	Allows selection of IRQ priority.
PCI Slot 3 IRQ Priority	<ul style="list-style-type: none"> <li>• <b>Auto (default)</b></li> <li>9</li> <li>10</li> <li>11</li> </ul>	Allows selection of IRQ priority.
PCI Slot 4 IRQ Priority	<ul style="list-style-type: none"> <li>• <b>Auto (default)</b></li> <li>9</li> <li>10</li> <li>11</li> </ul>	Allows selection of IRQ priority.
PCI Slot 5 IRQ Priority	No options	Always set to Auto.

## 4.4.2 Boot Configuration Submenu

To access this submenu, select Advanced on the menu bar, then Boot Configuration.

Maintenance	Main	<b>Advanced</b>	Security	Power	Boot	Exit
		PCI Configuration				
		<b>Boot Configuration</b>				
		Peripheral Configuration				
		IDE Configuration				
		Diskette Configuration				
		Event Log Configuration				
		Video Configuration				

The submenu represented by Table 68 is for setting Plug and Play options, resetting configuration data, and the power-on state of the Numlock key.

**Table 68. Boot Configuration Submenu**

Feature	Options	Description
Plug & Play O/S	<ul style="list-style-type: none"> <li>• <b>No (default)</b></li> <li>• Yes</li> </ul>	No lets the BIOS configure all devices. This setting is appropriate when using a Plug and Play operating system. Yes lets the operating system configure Plug and Play devices not required to boot the system. This option is available for use during lab testing.
Reset Config Data	<ul style="list-style-type: none"> <li>• <b>No (default)</b></li> <li>• Yes</li> </ul>	No does not clear the PCI/PnP configuration data stored in flash memory on the next boot. Yes clears the PCI/PnP configuration data stored in flash memory on the next boot.
Numlock	<ul style="list-style-type: none"> <li>• Off</li> <li>• <b>On (default)</b></li> </ul>	Specifies the power-on state of the Numlock feature on the numeric keypad of the keyboard.

### 4.4.3 Peripheral Configuration Submenu

To access this submenu, select Advanced on the menu bar, then Peripheral Configuration.

Maintenance	Main	<b>Advanced</b>	Security	Power	Boot	Exit
		PCI Configuration				
		Boot Configuration				
		<b>Peripheral Configuration</b>				
		IDE Configuration				
		Diskette Configuration				
		Event Log Configuration				
		Video Configuration				

The submenu represented in Table 69 is used for configuring computer peripherals.

**Table 69. Peripheral Configuration Submenu**

Feature	Options	Description
Serial Port A	<ul style="list-style-type: none"> <li>Disabled</li> <li>Enabled</li> <li><b>Auto (default)</b></li> </ul>	Configures serial port A. <i>Auto</i> assigns the first free COM port, normally COM1, the address 3F8h, and the interrupt IRQ4. An * (asterisk) displayed next to an address indicates a conflict with another device.
Base I/O Address (This feature is present only when Serial Port A is set to <i>Enabled</i> )	<ul style="list-style-type: none"> <li><b>3F8 (default)</b></li> <li>2F8</li> <li>3E8</li> <li>2E8</li> </ul>	Specifies the base I/O address for serial port A, if serial port A is Enabled.
Interrupt (This feature is present only when Serial Port A is set to <i>Enabled</i> )	<ul style="list-style-type: none"> <li>IRQ 3</li> <li><b>IRQ 4 (default)</b></li> </ul>	Specifies the interrupt for serial port A, if serial port A is Enabled.
Serial Port B	<ul style="list-style-type: none"> <li>Disabled</li> <li>Enabled</li> <li><b>Auto (default)</b></li> </ul>	Configures serial port B. <i>Auto</i> assigns the first free COM port, normally COM2, the address 2F8h, and the interrupt IRQ3. An * (asterisk) displayed next to an address indicates a conflict with another device.
Base I/O Address (This feature is present only when Serial Port B is set to <i>Enabled</i> )	<ul style="list-style-type: none"> <li><b>2F8 (default)</b></li> <li>3E8</li> <li>2E8</li> </ul>	Specifies the base I/O address for serial port B.
Interrupt (This feature is present only when Serial Port B is set to <i>Enabled</i> )	<ul style="list-style-type: none"> <li><b>IRQ 3 (default)</b></li> <li>IRQ 4</li> </ul>	Specifies the interrupt for serial port B.

continued

**Table 69. Peripheral Configuration Submenu** (continued)

Feature	Options	Description
Parallel Port	<ul style="list-style-type: none"> <li>Disabled</li> <li>Enabled</li> <li><b>Auto (default)</b></li> </ul>	Configures the parallel port. <i>Auto</i> assigns LPT1 the address 378h and the interrupt IRQ7. An * (asterisk) displayed next to an address indicates a conflict with another device.
Mode	<ul style="list-style-type: none"> <li>Output Only</li> <li><b>Bi-directional (default)</b></li> <li>EPP</li> <li>ECP</li> </ul>	Selects the mode for the parallel port. Not available if the parallel port is disabled. <i>Output Only</i> operates in AT <sup>+</sup> -compatible mode. <i>Bi-directional</i> operates in PS/2-compatible mode. <i>EPP</i> is Extended Parallel Port mode, a high-speed bi-directional mode. <i>ECP</i> is Enhanced Capabilities Port mode, a high-speed bi-directional mode.
Base I/O Address (This feature is present only when Parallel Port is set to <i>Enabled</i> )	<ul style="list-style-type: none"> <li><b>378 (default)</b></li> <li>278</li> </ul>	Specifies the base I/O address for the parallel port.
Interrupt (This feature is present only when Parallel Port is set to <i>Enabled</i> )	<ul style="list-style-type: none"> <li>IRQ 5</li> <li><b>IRQ 7 (default)</b></li> </ul>	Specifies the interrupt for the parallel port.
DMA Channel (This feature is present only when Parallel Port Mode is set to <i>ECP</i> )	<ul style="list-style-type: none"> <li>1</li> <li><b>3 (default)</b></li> </ul>	Specifies the DMA channel.
Audio Device	<ul style="list-style-type: none"> <li>Disabled</li> <li><b>Enabled (default)</b></li> </ul>	Enables or disables the onboard audio subsystem.
LAN Device (This feature is present only when there is onboard LAN)	<ul style="list-style-type: none"> <li>Disabled</li> <li><b>Enabled (default)</b></li> </ul>	Enables or disables the LAN device.
Legacy USB Support	<ul style="list-style-type: none"> <li>Disabled</li> <li><b>Enabled (default)</b></li> </ul>	Enables or disables legacy USB support. (See Section 3.5 on page 104 for more information.)

#### 4.4.4 IDE Configuration Submenu

To access this submenu, select Advanced on the menu bar, then IDE Configuration.

Maintenance	Main	<b>Advanced</b>	Security	Power	Boot	Exit
		PCI Configuration				
		Boot Configuration				
		Peripheral Configuration				
		<b>IDE Configuration</b>				
		Diskette Configuration				
		Event Log Configuration				
		Video Configuration				

The menu represented in Table 70 is used to configure IDE device options.

**Table 70. IDE Configuration Submenu**

Feature	Options	Description
IDE Controller	<ul style="list-style-type: none"> <li>• Disabled</li> <li>• Primary</li> <li>• Secondary</li> <li>• <b>Both (default)</b></li> </ul>	Specifies the integrated IDE controller. <i>Primary</i> enables only the primary IDE controller. <i>Secondary</i> enables only the secondary IDE controller. <i>Both</i> enables both IDE controllers.
Hard Disk Pre-Delay	<ul style="list-style-type: none"> <li>• <b>Disabled (default)</b></li> <li>• 3 Seconds</li> <li>• 6 Seconds</li> <li>• 9 Seconds</li> <li>• 12 Seconds</li> <li>• 15 Seconds</li> <li>• 21 Seconds</li> <li>• 30 Seconds</li> </ul>	Specifies the hard disk drive pre-delay.
Primary IDE Master	No options	Reports type of connected IDE device. When selected, displays the Primary IDE Master submenu.
Primary IDE Slave	No options	Reports type of connected IDE device. When selected, displays the Primary IDE Slave submenu.
Secondary IDE Master	No options	Reports type of connected IDE device. When selected, displays the Secondary IDE Master submenu.
Secondary IDE Slave	No options	Reports type of connected IDE device. When selected, displays the Secondary IDE Slave submenu.



### 4.4.4.1 Primary/Secondary IDE Master/Slave Submenus

To access these submenus, select Advanced on the menu bar, then IDE Configuration, and then the master or slave to be configured.

Maintenance	Main	<b>Advanced</b>	Security	Power	Boot	Exit
		PCI Configuration				
		Boot Configuration				
		Peripheral Configuration				
		<b>IDE Configuration</b>				
		<b>Primary IDE Master</b>				
		<b>Primary IDE Slave</b>				
		<b>Secondary IDE Master</b>				
		<b>Secondary IDE Slave</b>				
		Diskette Configuration				
		Event Log Configuration				
		Video Configuration				

There are four IDE submenus: primary master, primary slave, secondary master, and secondary slave. Table 71 shows the format of the IDE submenus. For brevity, only one example is shown.

**Table 71. Primary/Secondary IDE Master/Slave Submenus**

Feature	Options	Description
Drive Installed	None	Displays the type of drive installed.
Type	<ul style="list-style-type: none"> <li>• None</li> <li>• User</li> <li>• <b>Auto (default)</b></li> <li>• CD-ROM</li> <li>• ATAPI Removable</li> <li>• Other ATAPI</li> <li>• IDE Removable</li> </ul>	<p>Specifies the IDE configuration mode for IDE devices.</p> <p><i>User</i> allows capabilities to be changed.</p> <p><i>Auto</i> fills-in capabilities from ATA/ATAPI device.</p>
Maximum Capacity	None	Displays the capacity of the drive.
LBA Mode Control	<ul style="list-style-type: none"> <li>• Disabled</li> <li>• <b>Enabled (default)</b></li> </ul>	Enables or disables LBA mode control.
Multi-Sector Transfers	<ul style="list-style-type: none"> <li>• Disabled</li> <li>• 2 Sectors</li> <li>• 4 Sectors</li> <li>• 8 Sectors</li> <li>• <b>16 Sectors (default)</b></li> </ul>	<p>Specifies number of sectors per block for transfers from the hard disk drive to memory.</p> <p>Check the hard disk drive's specifications for optimum setting.</p>

continued

**Table 71. Primary/Secondary IDE Master/Slave Submenus** (continued)

Feature	Options	Description
PIO Mode <sup>(Note)</sup>	<ul style="list-style-type: none"> <li>• Auto</li> <li>• 0</li> <li>• 1</li> <li>• 2</li> <li>• <b>3 (default)</b></li> <li>• 4</li> </ul>	Specifies the PIO mode.
Ultra DMA	<ul style="list-style-type: none"> <li>• Disabled</li> <li>• Mode 0</li> <li>• Mode 1</li> <li>• <b>Mode 2 (default)</b></li> <li>• Mode 3</li> <li>• Mode 4</li> </ul>	Specifies the Ultra DMA mode for the drive.
Cable Detected <sup>(Note)</sup>	None	Displays the type of cable connected to the IDE interface: 40-conductor or 80-conductor (for ATA-66/100 devices).

Note: These configuration options appear only if an IDE device is installed.

### 4.4.5 Diskette Configuration Submenu

To access this menu, select Advanced on the menu bar, then Diskette Configuration.

Maintenance	Main	<b>Advanced</b>	Security	Power	Boot	Exit
		PCI Configuration				
		Boot Configuration				
		Peripheral Configuration				
		IDE Configuration				
		<b>Diskette Configuration</b>				
		Event Log Configuration				
		Video Configuration				

The submenu represented by Table 72 is used for configuring the diskette drive.

**Table 72. Diskette Configuration Submenu**

Feature	Options	Description
Diskette Controller	<ul style="list-style-type: none"> <li>Disabled</li> <li><b>Enabled (default)</b></li> </ul>	Disables or enables the integrated diskette controller.
Floppy A	<ul style="list-style-type: none"> <li>Not Installed</li> <li>360 KB 5¼"</li> <li>1.2 MB 5¼"</li> <li>720 KB 3½"</li> <li><b>1.44/1.25 MB 3½" (default)</b></li> <li>2.88 MB 3½"</li> </ul>	Specifies the capacity and physical size of diskette drive A.
Diskette Write Protect	<ul style="list-style-type: none"> <li><b>Disabled (default)</b></li> <li>Enabled</li> </ul>	Disables or enables write-protect for the diskette drive.

#### 4.4.6 Event Log Configuration Submenu

To access this menu, select Advanced on the menu bar, then Event Log Configuration.

Maintenance	Main	<b>Advanced</b>	Security	Power	Boot	Exit
		PCI Configuration				
		Boot Configuration				
		Peripheral Configuration				
		IDE Configuration				
		Diskette Configuration				
		<b>Event Log Configuration</b>				
		Video Configuration				

The submenu represented by Table 73 is used to configure the event logging features.

**Table 73. Event Log Configuration Submenu**

Feature	Options	Description
Event log	No options	Indicates if there is space available in the event log.
Event log validity	No options	Indicates if the contents of the event log are valid.
View event log	[Enter]	Displays the event log.
Clear all event logs	<ul style="list-style-type: none"> <li>• <b>No (default)</b></li> <li>• Yes</li> </ul>	Clears the event log after rebooting.
Event Logging	<ul style="list-style-type: none"> <li>• Disabled</li> <li>• <b>Enabled (default)</b></li> </ul>	Enables logging of events.
Mark events as read	<ul style="list-style-type: none"> <li>• <b>Yes (default)</b></li> <li>• No</li> </ul>	Marks all events as read.

### 4.4.7 Video Configuration Submenu

To access this menu, select Advanced on the menu bar, then Video Configuration.

Maintenance	Main	<b>Advanced</b>	Security	Power	Boot	Exit
		PCI Configuration				
		Boot Configuration				
		Peripheral Configuration				
		IDE Configuration				
		Diskette Configuration				
		Event Log Configuration				
		<b>Video Configuration</b>				

The submenu represented in Table 74 is for configuring the video features.

**Table 74. Video Configuration Submenu**

Feature	Options	Description
Primary Video Adapter	<ul style="list-style-type: none"> <li>• <b>AGP (default)</b></li> <li>• PCI</li> </ul>	Selects primary video adapter to be used during boot.
AGP Hardware Detected	No options	<p><i>Integrated</i> indicates that the onboard graphics subsystem is enabled on D815EEA2 boards only.</p> <p><i>1x AGP Card, 2x AGP Card, or 4x AGP Card</i> indicates that the BIOS has detected a 1x, 2x, or 4x AGP Card. Installing an add-in AGP card disables the D815EEA2 board's onboard graphics subsystem.</p>

## 4.5 Security Menu

To access this menu, select Security from the menu bar at the top of the screen.

Maintenance	Main	Advanced	<b>Security</b>	Power	Boot	Exit
-------------	------	----------	-----------------	-------	------	------

The menu represented by Table 75 is for setting passwords and security features.

**Table 75. Security Menu**

If no password entered previously:		
Feature	Options	Description
Supervisor Password Is	No options	Reports if there is a supervisor password set.
User Password Is	No options	Reports if there is a user password set.
Set Supervisor Password	Password can be up to seven alphanumeric characters.	Specifies the supervisor password.
Set User Password	Password can be up to seven alphanumeric characters.	Specifies the user password.
Clear User Password (Note 1)	<ul style="list-style-type: none"> <li>• <b>Yes (default)</b></li> <li>• No</li> </ul>	Clears the user password.
User Access Level (Note 2)	<ul style="list-style-type: none"> <li>• Limited</li> <li>• No Access</li> <li>• View Only</li> <li>• <b>Full (default)</b></li> </ul>	Sets BIOS Setup Utility access rights for user level.
Unattended Start (Notes 1, 3, and 4)	<ul style="list-style-type: none"> <li>• Enabled</li> <li>• <b>Disabled (default)</b></li> </ul>	Enabled allows system to complete the boot process without a password. The keyboard remains locked until a password is entered. A password is required to boot from a diskette.

**Notes:**

1. This feature appears only if a user password has been set.
2. This feature appears only if both a user password and a supervisor password have been set.
3. If both Legacy USB Support (in the Peripheral Configuration submenu) and Unattended Start (in the Security menu) are enabled, USB aware operating systems can unlock a PS/2 style keyboard and mouse without requiring the user to enter a password.
4. When Unattended Start is enabled, a USB aware operating system may override user password protection if used in conjunction with a USB keyboard and mouse without requiring the user to enter a password.

## 4.6 Power Menu

To access this menu, select Power from the menu bar at the top of the screen.

Maintenance	Main	Advanced	Security	<b>Power</b>	Boot	Exit
-------------	------	----------	----------	--------------	------	------

The menu represented in Table 76 is for setting the power management features.

**Table 76. Power Menu**

Feature	Options	Description
APM	No options	Sets the APM power management options.
ACPI	No options	Sets the ACPI power management options.
After Power Failure	<ul style="list-style-type: none"> <li>• Stays Off</li> <li>• <b>Last State (default)</b></li> <li>• Power On</li> </ul>	<p>Specifies the mode of operation if an AC power loss occurs.</p> <p><i>Stays Off</i> keeps the power off until the power button is pressed.</p> <p><i>Last State</i> restores the previous power state before power loss occurred.</p> <p><i>Power On</i> restores power to the computer.</p>
Wake on LAN (This feature is present only when there is no onboard LAN subsystem.)	<ul style="list-style-type: none"> <li>• <b>Stay Off (default)</b></li> <li>• Power-On</li> </ul>	In APM soft-off mode only, determines how the system responds to a LAN wake up event.
Wake on PME	<ul style="list-style-type: none"> <li>• <b>Stay Off (default)</b></li> <li>• Power-On</li> </ul>	In APM soft-off mode only, determines how the system responds to a PCI-PME wake up event.
Wake on Modem Ring	<ul style="list-style-type: none"> <li>• <b>Stay Off (default)</b></li> <li>• Power-On</li> </ul>	In APM soft-off mode only, specifies how the computer responds to a Modem Ring wake up event on an installed modem.

### 4.6.1 APM Submenu

To access this menu, select Power on the menu bar, then APM.

Maintenance	Main	Advanced	Security	<b>Power</b>	Boot	Exit
				APM		
				ACPI		

The submenu represented in Table 77 is for setting APM power options.

**Table 77. APM Submenu**

Feature	Options	Description
Power Management	<ul style="list-style-type: none"> <li>• Disabled</li> <li>• <b>Enabled (default)</b></li> </ul>	Enables or disables the APM feature.
Inactivity Timer	<ul style="list-style-type: none"> <li>• Off</li> <li>• 1 Minute</li> <li>• 5 Minutes</li> <li>• 10 Minutes</li> <li>• <b>20 Minutes (default)</b></li> <li>• 30 Minutes</li> <li>• 60 Minutes</li> <li>• 120 Minutes</li> </ul>	Specifies the amount of time before the computer enters APM standby mode.
Hard Drive	<ul style="list-style-type: none"> <li>• Disabled</li> <li>• <b>Enabled (default)</b></li> </ul>	Enables power management for hard disks during APM standby mode.



## 4.6.2 ACPI Submenu

To access this menu, select Power on the menu bar, then ACPI.

Maintenance	Main	Advanced	Security	<b>Power</b>	Boot	Exit
				APM		
				<b>ACPI</b>		

The submenu represented in Table 78 is for setting ACPI power options.

**Table 78. ACPI Submenu**

Feature	Options	Description
ACPI Suspend State	<ul style="list-style-type: none"> <li>• <b>S1 State (default)</b></li> <li>• S3 State</li> </ul>	Specifies the ACPI sleep state.
Video Repost (This feature is present only when ACPI Suspend State is set to S3)	<ul style="list-style-type: none"> <li>• <b>Disabled (default)</b></li> <li>• Enabled</li> </ul>	Allows the video BIOS to be initialized coming out of the S3 state. Some video controllers require this option to be enabled. This feature is present only if the ACPI suspend state is set to S3 state.
Wake on LAN from S5	<ul style="list-style-type: none"> <li>• <b>Stay Off (default)</b></li> <li>• Power On</li> </ul>	In ACPI soft-off mode only, determines how the system responds to a LAN wake up event when the system is in the ACPI soft-off mode.

## 4.7 Boot Menu

To access this menu, select Boot from the menu bar at the top of the screen.

Maintenance	Main	Advanced	Security	Power	<b>Boot</b>	Exit
-------------	------	----------	----------	-------	-------------	------

The menu represented in Table 79 is used to set the boot features and the boot sequence.

**Table 79. Boot Menu**

Feature	Options	Description
Quiet Boot	<ul style="list-style-type: none"> <li>• Disabled</li> <li>• <b>Enabled (default)</b></li> </ul>	<p><i>Disabled</i> displays normal POST messages.</p> <p><i>Enabled</i> displays OEM graphic instead of POST messages.</p>
Intel Rapid BIOS Boot	<ul style="list-style-type: none"> <li>• Disabled</li> <li>• <b>Enabled (default)</b></li> </ul>	Enables the computer to boot without running certain POST tests.
Scan User Flash Area	<ul style="list-style-type: none"> <li>• <b>Disabled (default)</b></li> <li>• Enabled</li> </ul>	Enables the BIOS to scan the flash memory for user binary files that are executed at boot time.
Boot Device Priority	No options	Specifies the boot sequence from the available types of boot devices.
Hard Disk Drives	No options	Specifies the boot sequence from the available hard disk drives.
Removeable Devices	No options	Specifies the boot sequence from the available removable devices.
ATAPI CDROM Drives	No options	Specifies the boot sequence from the available ATAPI CD-ROM drives.

### 4.7.1 Boot Device Priority Submenu

To access this menu, select Boot on the menu bar, then Boot Devices Priority.

Maintenance	Main	Advanced	Security	Power	<b>Boot</b>	Exit
						<b>Boot Device Priority</b>
						Hard Disk Drives
						Removeable Devices
						ATAPI CDROM Drives

The submenu represented in Table 80 is for setting boot devices priority.

**Table 80. Boot Device Priority Submenu**

Feature	Options	Description
1 <sup>st</sup> Boot Device 2 <sup>nd</sup> Boot Device 3 <sup>rd</sup> Boot Device 4 <sup>th</sup> Boot Device (Note 1)	<ul style="list-style-type: none"> <li>• Removable Dev.</li> <li>• Hard Drive</li> <li>• ATAPI CD-ROM</li> <li>• Intel UNDI, PXE</li> <li>• Disabled</li> </ul>	<p>Specifies the boot sequence from the available types of boot devices. To specify boot sequence:</p> <ol style="list-style-type: none"> <li>1. Select the boot device with &lt;↑&gt; or &lt;↓&gt;.</li> <li>2. Press &lt;Enter&gt; to set the selection as the intended boot device.</li> </ol> <p>The operating system assigns a drive letter to each boot device in the order listed. Changing the order of the devices changes the drive lettering. The default settings for the first through final boot devices are, respectively, listed below. The BIOS supports up to sixteen total boot devices in any combination of the boot device types below, with respect to these maximums per type.</p> <ul style="list-style-type: none"> <li>• Removable Dev. (maximum of four)</li> <li>• Hard Drive (maximum of twelve)</li> <li>• ATAPI CD-ROM (maximum of four)</li> <li>• Intel® UNDI, PXE (maximum of five) (Note 2)</li> </ul> <p>The boot devices appear in order by type. For example, assume that the default boot order is preserved and that seven boot devices of the following types are installed on the system: two removable devices, two hard drives, two ATAPI CD-ROMs, and an Intel UNDI (Universal Network Device Interface), PXE device. Both removable devices would appear as the first and second boot devices, the two hard drives would appear as the third and fourth, the two ATAPI CD-ROM drives would appear as the fifth and sixth, and the Intel UNDI, PXE device would appear as the seventh boot device.</p>

**Notes:**

1. After the predefined boot device types (removable devices, hard drives, and ATAPI CD-ROM drives), the entries in this list will reflect as many boot entry vector (BEV) boot devices (for example, Intel UNDI, PXE devices) and SCSI CD-ROM drives as are installed, up to the five BEV boot devices supported by the BIOS.
2. While the predefined boot device types are listed individually in submenus by type, the BEV devices and SCSI CD-ROM drives are all listed at this level.

## 4.7.2 Hard Disk Drives Submenu

To access this menu, select Boot on the menu bar, then Hard Disk Drives.

Maintenance	Main	Advanced	Security	Power	<b>Boot</b>	Exit
						Boot Device Priority
						<b>Hard Disk Drives</b>
						Removeable Devices
						ATAPI CDROM Drives

The submenu represented in Table 81 is for setting hard disk drive priority.

**Table 81. Hard Disk Drives Submenu**

Feature	Options	Description
1 <sup>st</sup> Hard Disk Drive (Note)	Dependent on installed hard drives	Specifies the boot sequence from the available hard disk drives. To specify boot sequence: 1. Select the boot device with <↑> or <↓>. 2. Press <Enter> to set the selection as the intended boot device.

Note: This boot device submenu appears only if at least one boot device of this type is installed. This list will display up to twelve hard disk drives, the maximum number of hard disk drives supported by the BIOS.

## 4.7.3 Removable Devices Submenu

To access this menu, select Boot on the menu bar, then Removable Devices.

Maintenance	Main	Advanced	Security	Power	<b>Boot</b>	Exit
						Boot Device Priority
						Hard Disk Drives
						<b>Removeable Devices</b>
						ATAPI CDROM Drives

The submenu represented in Table 82 is for setting removable device priority.

**Table 82. Removeable Devices Submenu**

Feature	Options	Description
1 <sup>st</sup> Removeable Device (Note)	Dependent on installed removable devices	Specifies the boot sequence from the available removable devices. To specify boot sequence: 1. Select the boot device with <↑> or <↓>. 2. Press <Enter> to set the selection as the intended boot device.

Note: This boot device submenu appears only if at least one boot device of this type is installed. This list will display up to four removable devices, the maximum number of removable devices supported by the BIOS.

## 4.7.4 ATAPI CDROM Drives Submenu

To access this menu, select Boot on the menu bar, then ATAPI CDROM Drives.

Maintenance	Main	Advanced	Security	Power	<b>Boot</b>	Exit
						Boot Device Priority
						Hard Disk Drives
						Removeable Devices
						<b>ATAPI CDROM Drives</b>

The submenu represented in Table 83 is for setting ATAPI CDROM drive priority.

**Table 83. ATAPI CDROM Drives Submenu**

Feature	Options	Description
1 <sup>st</sup> ATAPI CDROM Drive (Note)	Dependent on installed ATAPI CDROM drives	Specifies the boot sequence from the available ATAPI CDROM drives. To specify boot sequence: <ol style="list-style-type: none"> <li>1. Select the boot device with &lt;↑&gt; or &lt;↓&gt;.</li> <li>2. Press &lt;Enter&gt; to set the selection as the intended boot device.</li> </ol>

Note: This boot device submenu appears only if at least one boot device of this type is installed. This list will display up to four ATAPI CDROM drives, the maximum number of ATAPI CDROM drives supported by the BIOS.

## 4.8 Exit Menu

To access this menu, select Exit from the menu bar at the top of the screen.

Maintenance	Main	Advanced	Security	Power	Boot	<b>Exit</b>
-------------	------	----------	----------	-------	------	-------------

The menu represented in Table 84 is for exiting the BIOS Setup program, saving changes, and loading and saving defaults.

**Table 84. Exit Menu**

Feature	Description
Exit Saving Changes	Exits and saves the changes in CMOS SRAM.
Exit Discarding Changes	Exits without saving any changes made in the BIOS Setup program.
Load Setup Defaults	Loads the factory default values for all the Setup options.
Load Custom Defaults	Loads the custom defaults for Setup options.
Save Custom Defaults	Saves the current values as custom defaults. Normally, the BIOS reads the Setup values from flash memory. If this memory is corrupted, the BIOS reads the custom defaults. If no custom defaults are set, the BIOS reads the factory defaults.
Discard Changes	Discards changes without exiting Setup. The option values present when the computer was turned on are used.



# 5 Error Messages and Beep Codes

## What This Chapter Contains

5.1	BIOS Error Messages.....	135
5.2	Port 80h POST Codes.....	137
5.3	Bus Initialization Checkpoints.....	141
5.4	Speaker.....	142
5.5	BIOS Beep Codes.....	143

## 5.1 BIOS Error Messages

Table 85 lists the error messages and provides a brief description of each.

**Table 85. BIOS Error Messages**

Error Message	Explanation
GA20 Error	An error occurred with Gate A20 when switching to protected mode during the memory test.
Pri Master HDD Error Pri Slave HDD Error Sec Master HDD Error Sec Slave HDD Error	Could not read sector from corresponding drive.
Pri Master Drive - ATAPI Incompatible Pri Slave Drive - ATAPI Incompatible Sec Master Drive - ATAPI Incompatible Sec Slave Drive - ATAPI Incompatible	Corresponding drive is not an ATAPI device. Run Setup to make sure device is selected correctly.
A: Drive Error	No response from diskette drive.
Cache Memory Bad	An error occurred when testing L2 cache. Cache memory may be bad.
CMOS Battery Low	The battery may be losing power. Replace the battery soon.
CMOS Display Type Wrong	The display type is different than what has been stored in CMOS. Check Setup to make sure type is correct.
CMOS Checksum Bad	The CMOS checksum is incorrect. CMOS memory may have been corrupted. Run Setup to reset values.
CMOS Settings Wrong	CMOS values are not the same as the last boot. These values have either been corrupted or the battery has failed.
CMOS Date/Time Not Set	The time and/or date values stored in CMOS are invalid. Run Setup to set correct values.
DMA Error	Error during read/write test of DMA controller.
FDC Failure	Error occurred trying to access diskette drive controller.
HDC Failure	Error occurred trying to access hard disk controller.

continued

**Table 85. BIOS Error Messages** (continued)

<b>Error Message</b>	<b>Explanation</b>
Checking NVRAM.....	NVRAM is being checked to see if it is valid.
Update OK!	NVRAM was invalid and has been updated.
Updated Failed	NVRAM was invalid but was unable to be updated.
Keyboard Error	Error in the keyboard connection. Make sure keyboard is connected properly.
KB/Interface Error	Keyboard interface test failed.
Memory Size Decreased	Memory size has decreased since the last boot. If no memory was removed then memory may be bad.
Memory Size Increased	Memory size has increased since the last boot. If no memory was added there may be a problem with the system.
Memory Size Changed	Memory size has changed since the last boot. If no memory was added or removed then memory may be bad.
No Boot Device Available	System did not find a device to boot.
Off Board Parity Error	A parity error occurred on an off-board card. This error is followed by an address.
On Board Parity Error	A parity error occurred in onboard memory. This error is followed by an address.
Parity Error	A parity error occurred in onboard memory at an unknown address.
NVRAM/CMOS/PASSWORD cleared by Jumper	NVRAM, CMOS, and passwords have been cleared. The system should be powered down and the jumper removed.
<CTRL_N> Pressed	CMOS is ignored and NVRAM is cleared. User must enter Setup.



## 5.2 Port 80h POST Codes

During the POST, the BIOS generates diagnostic progress codes (POST-codes) to I/O port 80h. If the POST fails, execution stops and the last POST code generated is left at port 80h. This code is useful for determining the point where an error occurred.

Displaying the POST-codes requires an add-in card, often called a POST card (PCI not ISA). The POST card can decode the port and display the contents on a medium such as a seven-segment display.

The tables below offer descriptions of the POST codes generated by the BIOS. Table 86 defines the Uncompressed INIT Code Checkpoints, Table 87 describes the Boot Block Recovery Code Checkpoints, and Table 88 lists the Runtime Code Uncompressed in F000 Shadow RAM. Some codes are repeated in the tables because that code applies to more than one operation.

**Table 86. Uncompressed INIT Code Checkpoints**

Code	Description of POST Operation
D0	NMI is Disabled. Onboard KBC, RTC enabled (if present). Init code Checksum verification starting.
D1	Keyboard controller BAT test, CPU ID saved, and going to 4 GB flat mode.
D3	Do necessary chipset initialization, start memory refresh, and do memory sizing.
D4	Verify base memory.
D5	Init code to be copied to segment 0 and control to be transferred to segment 0.
D6	Control is in segment 0. To check recovery mode and verify main BIOS checksum. If either it is recovery mode or main BIOS checksum is bad, go to check point E0 for recovery else go to check point D7 for giving control to main BIOS.
D7	Find Main BIOS module in ROM image.
D8	Uncompress the main BIOS module.
D9	Copy main BIOS image to F000 shadow RAM and give control to main BIOS in F000 shadow RAM.

**Table 87. Boot Block Recovery Code Checkpoints**

Code	Description of POST Operation
E0	Onboard Floppy Controller (if any) is initialized. Compressed recovery code is uncompressed in F000:0000 in Shadow RAM and give control to recovery code in F000 Shadow RAM. Initialize interrupt vector tables, initialize system timer, initialize DMA controller and interrupt controller.
E8	Initialize extra (Intel Recovery) Module.
E9	Initialize floppy drive.
EA	Try to boot from floppy. If reading of boot sector is successful, give control to boot sector code.
EB	Booting from floppy failed, look for ATAPI (LS120, Zip) devices.
EC	Try to boot from ATAPI. If reading of boot sector is successful, give control to boot sector code.
EF	Booting from floppy and ATAPI device failed. Give two beeps. Retry the booting procedure again (go to check point E9).

**Table 88. Runtime Code Uncompressed in F000 Shadow RAM**

Code	Description of POST Operation
03	NMI is Disabled. To check soft reset/power-on.
05	BIOS stack set. Going to disable cache if any.
06	POST code to be uncompressed.
07	CPU init and CPU data area init to be done.
08	CMOS checksum calculation to be done next.
0B	Any initialization before keyboard BAT to be done next.
0C	KB controller I/B free. To issue the BAT command to keyboard controller.
0E	Any initialization after KB controller BAT to be done next.
0F	Keyboard command byte to be written.
10	Going to issue Pin-23,24 blocking/unblocking command.
11	Going to check pressing of <INS>, <END> key during power-on.
12	To init CMOS if "Init CMOS in every boot" is set or <END> key is pressed. Going to disable DMA and Interrupt controllers.
13	Video display is disabled and port-B is initialized. Chipset init about to begin.
14	8254 timer test about to start.
19	About to start memory refresh test.
1A	Memory Refresh line is toggling. Going to check 15 $\mu$ s ON/OFF time.
23	To read 8042 input port and disable Megakey GreenPC feature. Make BIOS code segment writeable.
24	To do any setup before Int vector init.
25	Interrupt vector initialization to begin. To clear password if necessary.
27	Any initialization before setting video mode to be done.
28	Going for monochrome mode and color mode setting.
2A	Different buses init (system, static, output devices) to start if present. (See Section 5.3 for details of different buses.)
2B	To give control for any setup required before optional video ROM check.
2C	To look for optional video ROM and give control.
2D	To give control to do any processing after video ROM returns control.
2E	If EGA/VGA not found then do display memory R/W test.
2F	EGA/VGA not found. Display memory R/W test about to begin.
30	Display memory R/W test passed. About to look for the retrace checking.
31	Display memory R/W test or retrace checking failed. To do alternate Display memory R/W test.
32	Alternate Display memory R/W test passed. To look for the alternate display retrace checking.
34	Video display checking over. Display mode to be set next.
37	Display mode set. Going to display the power-on message.
38	Different buses init (input, IPL, general devices) to start if present. (See Section 5.3 for details of different buses.)
39	Display different buses initialization error messages. (See Section 5.3 for details of different buses.)
3A	New cursor position read and saved. To display the Hit <DEL> message.

continued

**Table 88. Runtime Code Uncompressed in F000 Shadow RAM (continued)**

Code	Description of POST Operation
40	To prepare the descriptor tables.
42	To enter in virtual mode for memory test.
43	To enable interrupts for diagnostics mode.
44	To initialize data to check memory wrap around at 0:0.
45	Data initialized. Going to check for memory wrap around at 0:0 and finding the total system memory size.
46	Memory wrap around test done. Memory size calculation over. About to go for writing patterns to test memory.
47	Pattern to be tested written in extended memory. Going to write patterns in base 640k memory.
48	Patterns written in base memory. Going to find out amount of memory below 1 MB memory.
49	Amount of memory below 1 MB found and verified. Going to find out amount of memory above 1 MB memory.
4B	Amount of memory above 1 MB found and verified. Check for soft reset and going to clear memory below 1 MB for soft reset. (If power on, go to check point # 4Eh.)
4C	Memory below 1 MB cleared. (SOFT RESET) Going to clear memory above 1 MB.
4D	Memory above 1 MB cleared. (SOFT RESET) Going to save the memory size. (Go to check point # 52h.)
4E	Memory test started. (NOT SOFT RESET) About to display the first 64k memory size.
4F	Memory size display started. This will be updated during memory test. Going for sequential and random memory test.
50	Memory testing/initialization below 1 MB complete. Going to adjust displayed memory size for relocation/ shadow.
51	Memory size display adjusted due to relocation/ shadow. Memory test above 1 MB to follow.
52	Memory testing/initialization above 1 MB complete. Going to save memory size information.
53	Memory size information is saved. CPU registers are saved. Going to enter in real mode.
54	Shutdown successful, CPU in real mode. Going to disable gate A20 line and disable parity/NMI.
57	A20 address line, parity/NMI disable successful. Going to adjust memory size depending on relocation/shadow.
58	Memory size adjusted for relocation/shadow. Going to clear Hit <DEL> message.
59	Hit <DEL> message cleared. <WAIT...> message displayed. About to start DMA and interrupt controller test.
60	DMA page register test passed. To do DMA#1 base register test.
62	DMA#1 base register test passed. To do DMA#2 base register test.
65	DMA#2 base register test passed. To program DMA unit 1 and 2.
66	DMA unit 1 and 2 programming over. To initialize 8259 interrupt controller.
7F	Extended NMI sources enabling is in progress.
80	Keyboard test started. Clearing output buffer, checking for stuck key, to issue keyboard reset command.
81	Keyboard reset error/stuck key found. To issue keyboard controller interface test command.
82	Keyboard controller interface test over. To write command byte and init circular buffer.
83	Command byte written, global data init done. To check for lock-key.

continued

**Table 88. Runtime Code Uncompressed in F000 Shadow RAM (continued)**

Code	Description of POST Operation
84	Lock-key checking over. To check for memory size mismatch with CMOS.
85	Memory size check done. To display soft error and check for password or bypass setup.
86	Password checked. About to do programming before setup.
87	Programming before setup complete. To uncompress SETUP code and execute CMOS setup.
88	Returned from CMOS setup program and screen is cleared. About to do programming after setup.
89	Programming after setup complete. Going to display power-on screen message.
8B	First screen message displayed. <WAIT...> message displayed. PS/2 Mouse check and extended BIOS data area allocation to be done.
8C	Setup options programming after CMOS setup about to start.
8D	Going for hard disk controller reset.
8F	Hard disk controller reset done. Floppy setup to be done next.
91	Floppy setup complete. Hard disk setup to be done next.
95	Init of different buses optional ROMs from C800 to start. (See Section 5.3 for details of different buses.)
96	Going to do any init before C800 optional ROM control.
97	Any init before C800 optional ROM control is over. Optional ROM check and control will be done next.
98	Optional ROM control is done. About to give control to do any required processing after optional ROM returns control and enable external cache.
99	Any initialization required after optional ROM test over. Going to setup timer data area and printer base address.
9A	Return after setting timer and printer base address. Going to set the RS-232 base address.
9B	Returned after RS-232 base address. Going to do any initialization before Coprocessor test.
9C	Required initialization before Coprocessor is over. Going to initialize the Coprocessor next.
9D	Coprocessor initialized. Going to do any initialization after Coprocessor test.
9E	Initialization after Coprocessor test is complete. Going to check extended keyboard, keyboard ID and num-lock.
A2	Going to display any soft errors.
A3	Soft error display complete. Going to set keyboard typematic rate.
A4	Keyboard typematic rate set. To program memory wait states.
A5	Going to enable parity/NMI.
A7	NMI and parity enabled. Going to do any initialization required before giving control to optional ROM at E000.
A8	Initialization before E000 ROM control over. E000 ROM to get control next.
A9	Returned from E000 ROM control. Going to do any initialization required after E000 optional ROM control.
AA	Initialization after E000 optional ROM control is over. Going to display the system configuration.
AB	Put INT13 module runtime image to shadow.
AC	Generate MP for multiprocessor support (if present).
AD	Put CGA INT10 module (if present) in Shadow.

continued

**Table 88. Runtime Code Uncompressed in F00 Shadow RAM (continued)**

Code	Description of POST Operation
AE	Uncompress SMBIOS module and init SMBIOS code and form the runtime SMBIOS image in shadow.
B1	Going to copy any code to specific area.
00	Copying of code to specific area done. Going to give control to INT-19 boot loader.

## 5.3 Bus Initialization Checkpoints

The system BIOS gives control to the different buses at several checkpoints to do various tasks. Table 89 describes the bus initialization checkpoints.

**Table 89. Bus Initialization Checkpoints**

Checkpoint	Description
2A	Different buses init (system, static, and output devices) to start if present.
38	Different buses init (input, IPL, and general devices) to start if present.
39	Display different buses initialization error messages.
95	Init of different buses optional ROMs from C800 to start.

While control is inside the different bus routines, additional checkpoints are output to port 80h as WORD to identify the routines under execution. In these WORD checkpoints, the low byte of the checkpoint is the system BIOS checkpoint from which the control is passed to the different bus routines. The high byte of the checkpoint is the indication of which routine is being executed in the different buses. Table 90 describes the upper nibble of the high byte and indicates the function that is being executed.

**Table 90. Upper Nibble High Byte Functions**

Value	Description
0	func#0, disable all devices on the bus concerned.
1	func#1, static devices init on the bus concerned.
2	func#2, output device init on the bus concerned.
3	func#3, input device init on the bus concerned.
4	func#4, IPL device init on the bus concerned.
5	func#5, general device init on the bus concerned.
6	func#6, error reporting for the bus concerned.
7	func#7, add-on ROM init for all buses.

Table 91 describes the lower nibble of the high byte and indicates the bus on which the routines are being executed.

**Table 91. Lower Nibble High Byte Functions**

Value	Description
0	Generic DIM (Device Initialization Manager)
1	Onboard system devices
2	ISA devices
3	EISA devices
4	ISA PnP devices
5	PCI devices

## 5.4 Speaker

A 47  $\Omega$  inductive speaker is mounted on the D815EEA2 and D815EPEA2 boards. The speaker provides audible error code (beep code) information during POST.

For information about	Refer to
The location of the onboard speaker	Figure 2, page 16

## 5.5 BIOS Beep Codes

Whenever a recoverable error occurs during POST, the BIOS displays an error message describing the problem (see Table 92). The BIOS also issues a beep code (one long tone followed by two short tones) during POST if the video configuration fails (a faulty video card or no card installed) or if an external ROM module does not properly checksum to zero.

An external ROM module (for example, a video BIOS) can also issue audible errors, usually consisting of one long tone followed by a series of short tones. For more information on the beep codes issued, check the documentation for that external device.

There are several POST routines that issue a POST terminal error and shut down the system if they fail. Before shutting down the system, the terminal-error handler issues a beep code signifying the test point error, writes the error to I/O port 80h, attempts to initialize the video and writes the error in the upper left corner of the screen (using both monochrome and color adapters).

If POST completes normally, the BIOS issues one short beep before passing control to the operating system.

**Table 92. Beep Codes**

Beep	Description
1	Refresh failure
2	Parity cannot be reset
3	First 64 KB memory failure
4	Timer not operational
5	Not used
6	8042 GateA20 cannot be toggled
7	Exception interrupt error
8	Display memory R/W error
9	Not used
10	CMOS Shutdown register test error
11	Invalid BIOS (e.g., POST module not found, etc.)

## 5.6 Diagnostic LEDs (Optional)

The optional enhanced diagnostics feature consists of a hardware decoder and four LEDs located between the LAN connector and the parallel port connector on the back panel. This feature requires no modifications to the chassis (other than I/O back panel shield) or cabling.

Figure 26 shows the location of the diagnostic LEDs. Table 93 lists the diagnostic codes displayed by the LEDs.

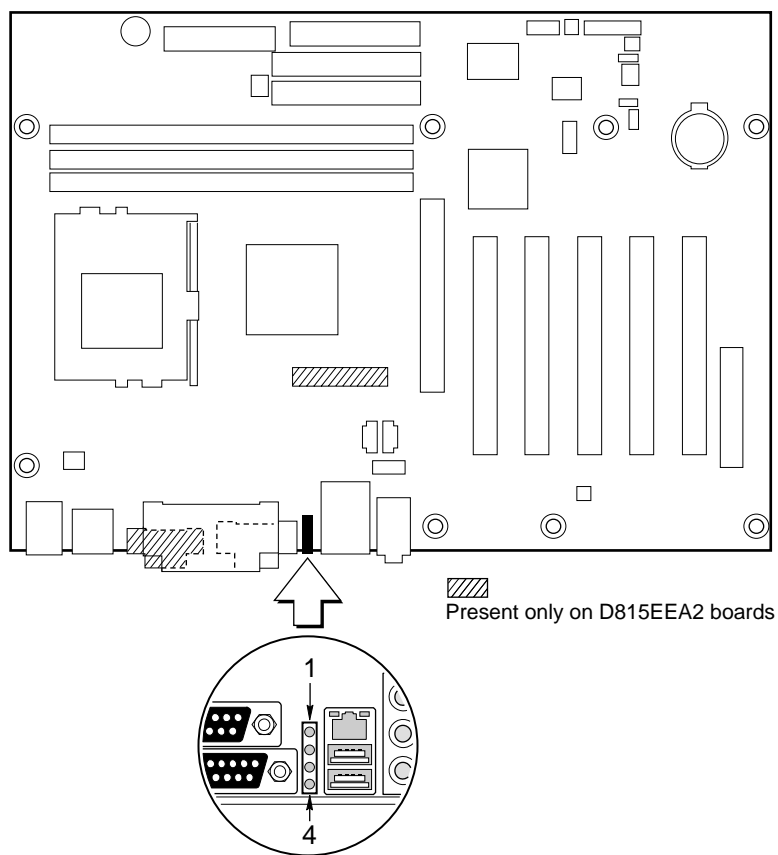









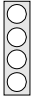







OM11462A

Figure 26. Diagnostic LEDs

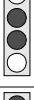

**Table 93. Diagnostic LED Codes**

Display		BIOS Operation	Display		BIOS Operation
	Amber Amber Amber Amber	Power on, starting BIOS		Amber Amber Amber Green	Undefined
	Green Amber Amber Amber	Recovery mode		Green Amber Amber Green	Undefined
	Amber Green Amber Amber	Processor, cache, etc.		Amber Green Amber Green	Undefined
	Green Green Amber Amber	Memory, auto-size, shadow, etc.		Green Green Amber Green	Undefined
	Amber Amber Green Amber	PCI bus initialization		Amber Amber Green Green	Undefined
	Green Amber Green Amber	Video		Green Amber Green Green	Undefined
	Amber Green Green Amber	IDE bus initialization		Amber Green Green Green	Undefined
	Green Green Green Amber	USB initialization		Green Green Green Green	Booting operating system

Note: Undefined states are reserved for future use.

⇒ **NOTE**

*After the computer has booted, the diagnostic LEDs remain green during normal operation.*

